

VIPER[®]

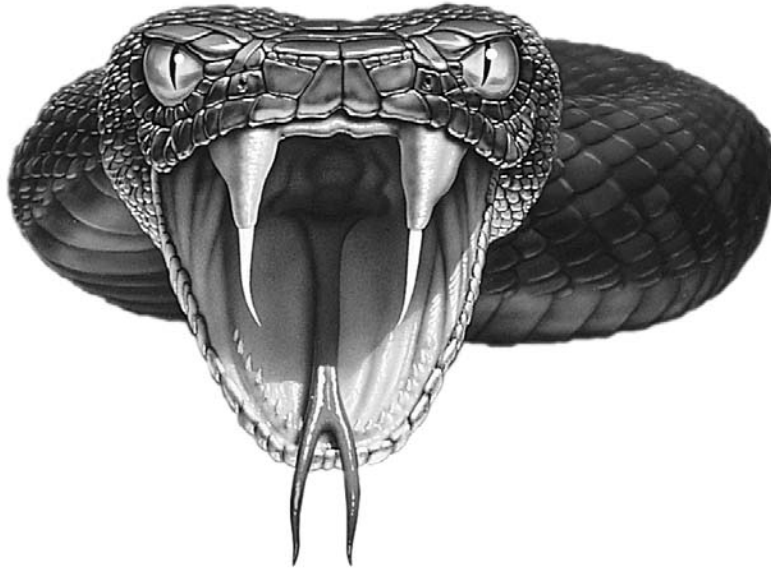

Model 791 XV

Installation Guide

NOTE: This product is intended for installation by a professional installer only! Any attempt to install this product by any person other than a trained professional may result in severe damage to a vehicle's electrical system and components.

driven to excel
Directed[®]
ELECTRONICS, INC.

© 2003 Directed Electronics, Inc. Vista, CA
N564V 6-03

Bitwriter™, Code Hopping™, Doubleguard®, ESP™, FailSafe®, Ghost Switch™, Learn Routine™, Nite-Lite®, Nuisance Prevention Circuitry®, NPC®, Revenger®, Silent Mode™, Soft Chirp®, Stinger®, Valet®, Vehicle Recovery System®, VRS®, and Warn Away® are all Trademarks or Registered Trademarks of Directed Electronics, Inc.



The Bitwriter® (p/n 998T) requires chip version 1.4 or newer to program this unit.

New Software Compatibility for 103T Keypad

This unit now has software that allows arming with entry delay when used in conjunction with the optional **103T** Keypad. Refer to the 103T Owner's Guide for details.

table of contents

| | | | |
|--|----|---|----|
| what is included | 3 | plug-in LED and valet/program switch | 32 |
| warning! safety first | 4 | programmer interface, 3-pin black plug | 32 |
| installation points to remember | 5 | shock sensor harness, 4-pin connector | 33 |
| before beginning the installation | 5 | tach learning | 34 |
| after the installation | 5 | programming jumpers | 34 |
| deciding on component locations | 6 | light flash (+)/(-) | 35 |
| locations for the control module | 6 | tach threshold on/off | 35 |
| locations for the siren | 6 | transmitter/receiver learn routine™ | 35 |
| locations for stinger doubleguard shock sensor | 7 | transmitter configurations | 38 |
| locations for the status LED | 8 | standard configuration | 38 |
| locations for valet/program switch | 8 | remote control diagram | 39 |
| locations for the optional starter kill relay | 9 | standard mode configuration | 40 |
| locations for the relay satellite | 9 | multi-level security arming | 41 |
| finding the wires you need | 9 | system features learn routine | 42 |
| obtaining constant 12V | 9 | feature menus | 44 |
| finding the starter wire | 10 | menu #1 - basic features | 44 |
| finding the 12V switched ignition wire | 10 | menu #3 - remote start options | 45 |
| finding the tachometer wire | 11 | menu #2 - advanced features | 45 |
| finding the wait-to-start bulb wire for diesels | 11 | feature descriptions | 46 |
| finding the accessory wire | 11 | menu #1 - basic features | 46 |
| finding the door pin switch circuit | 12 | menu #2 - advanced features | 47 |
| finding a (+) parking light wire | 12 | menu #3 - remote start options | 49 |
| making your wiring connections | 13 | nuisance prevention circuitry™ | 50 |
| primary harness (H1), 12-pin connector | 14 | valet mode | 51 |
| secondary harness (H2), 6-pin connector | 14 | timer mode | 51 |
| door lock harness, 3-pin connector | 15 | table of zones | 52 |
| remote start primary harness, 7-pin connector | 15 | shutdown diagnostics | 52 |
| heavy gauge inline connector key switch interface | 16 | to perform shutdown diagnostics | 52 |
| remote start secondary harness (H3), 5-pin connector | 16 | long term event history | 53 |
| primary harness (H1) wire connection guide | 17 | safety check | 54 |
| secondary harness (H2) wire connection guide | 21 | troubleshooting | 55 |
| relay key switch interface wire connection guide | 24 | remote start troubleshooting | 55 |
| remote start secondary harness (H3) wire connection guide | 25 | alarm troubleshooting | 55 |
| neutral safety switch interface | 27 | wiring quick reference guide | 57 |
| testing the neutral safety switch | 27 | relay satellite wiring quick reference guide | 58 |
| bypassing GM vehicle anti-theft systems (VATS) | 30 | | |
| 1995 and newer vehicle anti-theft systems (immobilizers) | 31 | | |
| passlock I and passlock II (PL-1 and PL-2) | 31 | | |
| passkey III (PK-3), transponder-based systems | 31 | | |

what is included

- The control module
- An XHF Plus receiver/antenna
- One remote transmitter P/N 479V
- A Stinger Doubleguard shock sensor
- A 514N Neosiren
- The plug-in status LED
- The plug-in Valet/Program switch
- A hood pinswitch
- A toggle (override) switch

warning! safety first

The following safety warnings must be observed at all times:

- Due to the complexity of this system, installation of this product must only be performed by an authorized Directed Electronics dealer.
- When properly installed, this system can start the vehicle via a command signal from the remote control transmitter. Therefore, never operate the system in an area that does not have adequate ventilation. The following precautions are the sole responsibility of the user; however, authorized Directed Electronics dealers should make the following recommendations to all users of this system:
 1. Never operate the system in an enclosed or partially enclosed area without ventilation (such as a garage).
 2. When parking in an enclosed or partially enclosed area or when having the vehicle serviced, the remote start system must be disabled using the installed toggle switch.
 3. It is the user's sole responsibility to properly handle and keep out of reach from children all remote control transmitters to assure that the system does not unintentionally remote start the vehicle.
 4. **THE USER MUST INSTALL A CARBON MONOXIDE DETECTOR IN OR ABOUT THE LIVING AREA ADJACENT TO THE VEHICLE. ALL DOORS LEADING FROM ADJACENT LIVING AREAS TO THE ENCLOSED OR PARTIALLY ENCLOSED VEHICLE STORAGE AREA MUST AT ALL TIMES REMAIN CLOSED.**
- Use of this product in a manner contrary to its intended mode of operation may result in property damage, personal injury, or death. Except when performing the Safety Check outlined in this installation guide, (1) Never remotely start the vehicle with the vehicle in gear, and (2) Never remotely start the vehicle with the keys in the ignition. The user will be responsible for having the neutral safety feature of the vehicle periodically checked, wherein the vehicle must not remotely start while the car is in gear. This testing should be performed by an authorized Directed Electronics dealer in accordance with the Safety Check outlined in this product installation guide. If the vehicle starts in gear, cease remote start operation immediately and consult with the user to fix the problem immediately.
- After the remote start module has been installed, test the remote start module in accordance with the Safety

Check outlined in this installation guide. If the vehicle starts when performing the Neutral Safety Shutdown Circuit test, the remote start unit has not been properly installed. The remote start module must be removed or properly reinstalled so that the vehicle does not start in gear. All installations must be performed by an authorized Directed Electronics dealer. **OPERATION OF THE REMOTE START MODULE IF THE VEHICLE STARTS IN GEAR IS CONTRARY TO ITS INTENDED MODE OF OPERATION. OPERATING THE REMOTE START SYSTEM UNDER THESE CONDITIONS MAY RESULT IN PROPERTY DAMAGE OR PERSONAL INJURY. IMMEDIATELY CEASE THE USE OF THE UNIT AND REPAIR OR DISCONNECT THE INSTALLED REMOTE START MODULE. DIRECTED ELECTRONICS, INC. WILL NOT BE HELD RESPONSIBLE OR PAY FOR INSTALLATION OR REINSTALLATION COSTS.**

installation points to remember

***IMPORTANT!** This product is designed for fuel-injected, automatic transmission vehicles only. Installing it in a standard transmission vehicle is dangerous and is contrary to its intended use.*

before beginning the installation

- Please read this entire installation guide before beginning the installation. The installation of this remote start system requires interfacing with many of the vehicle's systems. Many new vehicles use low-voltage or multiplexed systems that can be damaged by low resistance testing devices, such as test lights and logic probes (computer safe test lights). Test all circuits with a high quality digital multi-meter before making connections.
- Do not disconnect the battery if the vehicle has an anti-theft-coded radio. If equipped with an air bag, avoid disconnecting the battery if possible. Many airbag systems will display a diagnostic code through their warning lights after they lose power. Disconnecting the battery requires this code to be erased, which can require a trip to the dealer.
- Check with the customer on status LED location.
- Remove the domelight fuse. This prevents accidentally draining the battery.
- Roll down a window to avoid being locked out of the car.

after the installation

- Test all functions. The "Using Your System" section of the Owner's Guide is very helpful when testing.
- When testing, don't forget that this system is equipped with Nuisance Prevention Circuitry™ (NPC™). NPC can bypass trigger zones, making them appear to stop working. See the *Nuisance Prevention Circuitry* section.
- Review and complete the *Safety Check* section of this guide prior to the vehicle reassembly.

deciding on component locations

locations for the siren

Some things to remember about mounting the siren:

- Keep it away from heat sources, such as radiators, exhaust manifolds, turbochargers, and heat shields.
- Mount it where a thief cannot easily disconnect it, whether the hood is open or shut. Both the siren and its wires should be difficult to find. This usually involves disguising the wire to look like a factory harness.
- We recommend against grounding the siren to its mounting screws. Instead, we recommend running both the red and black wires into the passenger compartment and grounding to one common point for all devices. After all, both wires are the same length and come already bonded together. Whenever possible, conceal your wires in the factory harnesses or in the same style loom as the factory.
- When possible, place the siren on the same side of the vehicle as the control module, where its wires will reach the control module's wires without extending them. Always run the wires through the center of a grommet, never through bare metal!
- Point the siren down so water does not collect in it.

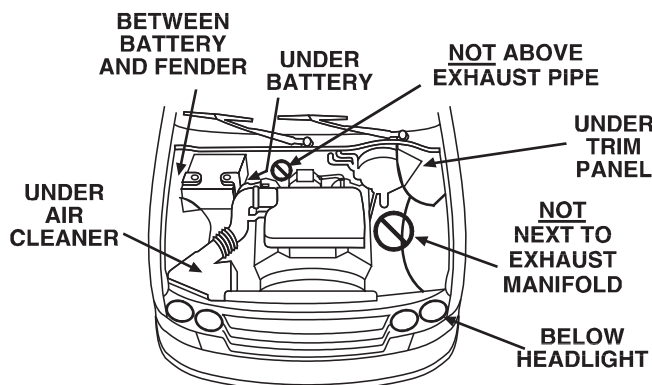

locations for the control module

Some things to remember about where to mount the control module:

- Never put the control module in the engine compartment!
- The first step in hot-wiring a vehicle is removing the driver's side under-dash panel to access the starter and ignition wires. If the control module is placed just behind the driver's side dash it can easily be disconnected.
- When mounting the control module, try to find a secure location that will not require you to extend the harnesses' wires (they are 1.5 meters long). Keep it away from the heater core (or any other heat sources) and any obvious leaks.

- The higher the control module is in the vehicle, the better the transmitter range will be. If you put the control module under a seat or inside a metal dashboard, range will diminish.

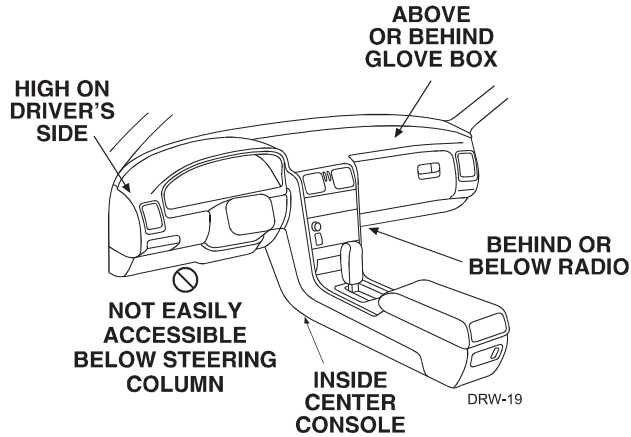

Some good control module locations: above the glove box, inside the center console, above the under-dash fuse box, above the radio, etc.

locations for stinger doubleguard shock sensor

Some things to remember about where to mount the shock sensor:

- Never put the Stinger® in the engine compartment!
- Find a spot close to the control module so that the wires do not need to be extended. Keep it away from the heater core (or any other heat sources) and any obvious leaks.

How the Stinger® is mounted is the most important factor in its performance. We recommend two methods:

- Using double-sided tape or hook-and-loop fastener to mount to a trim panel or an air duct, or
- Wire-tying to a wire harness.

If mounting the sensor where it cannot be easily reached for adjustment, hook-and-loop fastening tape (such as Velcro) is recommended for ease of removal for future adjustments.

***NOTE:** In many vehicles, tying the sensor to a steering column or screwing it to metal will result in poor sensitivity, especially at the rear of the vehicle.*

Locations for valet/program switch

IMPORTANT! When the vehicle is delivered, please show the user where this switch is located and how to disarm the system with it.

Ensure that the location you pick for the switch has sufficient clearance to the rear. The switch should be well hidden. It should be placed so passengers or stored items (such as in a glove box or center console) cannot accidentally hit it. The switch fits into a $\frac{9}{32}$ -inch hole.

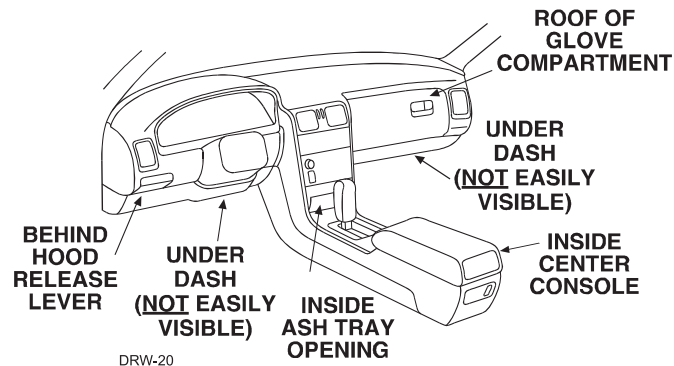

This system has Remote Valet. The user can enter and exit Valet® Mode without having to reach the Valet®/Program switch. This feature was introduced so that switch location was less critical in day-to-day use. As long as the Valet®/Program switch can be reached to disarm without a transmitter, easy access is not important.

Locations for the status LED

Things to remember when positioning the Status LED:

- It should be visible from both sides and the rear of the vehicle, if possible.
- It needs at least $\frac{1}{2}$ -inch clearance to the rear.
- It is easiest to remove a small panel, such as a switch blank or a dash bezel, before drilling a $\frac{9}{32}$ -inch hole.
- Use quick-disconnects near the LED wires if the panel is removable. This lets mechanics or other installers remove the panel without cutting the wires.

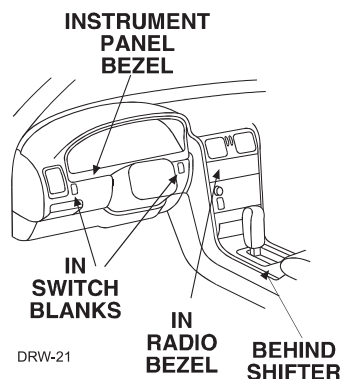

locations for the optional starter kill relay

If optional starter kill relay or its connections are immediately visible upon removal of the under-dash panel, they can easily be bypassed. Always make the relay and its connections difficult to discern from the factory wiring! Exposed yellow butt connectors do not look like factory parts, and will not fool anyone! For this reason, routing the optional starter kill wires away from the steering column is recommended.

locations for the relay satellite

The relay satellite wiring carries large amounts of current. The wires should not be extended and should be cut to the minimum length necessary. Since the relay satellite is functioning as the ignition switch in the vehicle, it is often convenient to mount the relay satellite close to the main ignition switch harness.

finding the wires you need

Now that you have decided where each component will be located, you're going to find the wires in the car that the security system will be connected to.

IMPORTANT! Do not use a 12V test light or logic probe (computer safe test light) to find these wires! Use a digital multimeter for all testing.

obtaining constant 12V

We recommend two possible sources for 12V constant: the (+) terminal of the battery, or the constant supply to the ignition switch. Always install a fuse within 12 inches of this connection. If the fuse also will be powering other circuits, such as door locks, a power window module, a Nite-Lite® headlight control system, etc., fuse accordingly.

IMPORTANT! Do not remove the fuse holder on the red wire. It ensures that the control module has its own fuse, of the proper value, regardless of how many accessories are added to the main power feed.

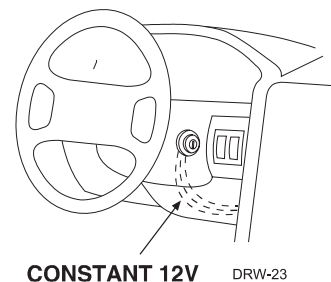
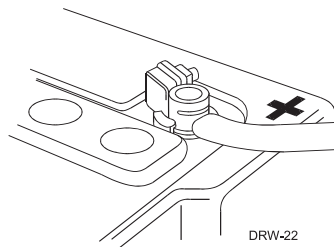
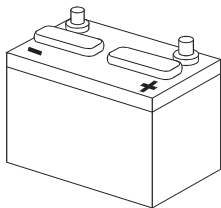

finding the 12V switched ignition wire

The ignition wire is powered when the key is in the run or start position. This is because the ignition wire powers the ignition system (spark plugs, coil) as well as the fuel delivery system (fuel pump, fuel injection computer). Accessory wires lose power when the key is in the start position to make more current available to the starter motor.

How to find (+)12V ignition with your multimeter:

1. Set to DCV or DC voltage (12V or 20V is fine).
2. Attach the (-) probe of the meter to chassis ground.
3. Probe the wire you suspect of being the ignition wire. The steering column harness or ignition switch harness is an excellent place to find this wire.
4. Turn the ignition key switch to the run position. If your meter reads (+)12V, go to the next step. If it doesn't, probe another wire.
5. Now turn the key to the start position. The meter display should stay steady, not dropping by more than a few tenths of a volt. If it drops close to or all the way to zero, go back to Step 3. If it stays steady at (+)12V, you have found an ignition wire.

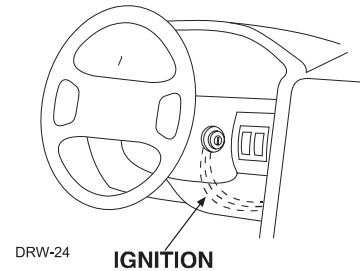

finding the starter wire

The starter wire provides 12V directly to the starter or to a relay controlling the starter. In some vehicles, it is necessary to power a cold start circuit. A cold start circuit will test exactly like a starter circuit, but it does not control the starter. Instead, the cold start circuit is used to prime the fuel injection system for starting when the vehicle is cold.

How to find the starter wire with your multimeter:

1. Set to DCV or DC voltage (12V or 20V is fine).
2. Attach the (-) probe of the meter to chassis ground.
3. Probe the wire you suspect of being the starter wire. The steering column is an excellent place to find this wire. Remember you do not need to interrupt the starter at the same point you test it. Hiding your optional starter kill relay and connections is always recommended.
4. Turn the ignition key switch to the start position. Make sure the car is not in gear! If your meter reads (+)12V, go to the next step. If it doesn't, probe another wire.
5. Cut the wire you suspect of being the starter wire.
6. Attempt to start the car. If the starter engages, reconnect it and go back to Step 3. If the starter does not turn over, you have the right wire.

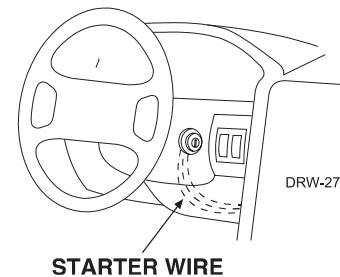

finding the accessory wire

An accessory wire will show +12V when the key is in the accessory and run positions. It will not show +12V during the cranking cycle. There will often be more than one accessory wire in the ignition harness. The correct accessory wire will power the vehicle's climate control system. Some vehicles may have separate wires for the blower motor and the air conditioning compressor. In such cases, it will be necessary to add a relay to power the second accessory wire.

finding the tachometer wire

To test for a tachometer wire, a multimeter capable of testing AC voltage must be used. The tachometer wire will show between 1V and 6V AC. In multi-coil ignition systems, the system can learn individual coil wires. Individual coil wires in a multi-coil ignition system will register lower amounts of AC voltage. Also, if necessary, the system can use a fuel injector control wire for engine speed sensing. Common locations for a tachometer wire are the ignition coil itself, the back of the gauges, engine computers, and automatic transmission computers.

IMPORTANT! Do not test tachometer wires using a test light or logic probe (computer safe test light)! This will damage the vehicle.

How to find a tachometer wire with your multimeter:

1. Set to ACV or AC voltage (12V or 20V is fine).
2. Attach the (-) probe of the meter to chassis ground.
3. Start and run the vehicle.
4. Probe the wire you suspect of being the tachometer wire with the red probe of the meter.
5. If this is the correct wire the meter will read between 1V and 6V.

finding the wait-to-start bulb wire for diesels

In diesel vehicles it is necessary to interface with the wire that turns on the WAIT TO START light in the dashboard. This wire illuminates the bulb until the vehicle's glow plugs are properly heated. When the light goes out the vehicle can be started. This wire is always available at the connector leading to the bulb in the dashboard. It can also be found at the Engine Control Module (ECM) in many vehicles.

To test and determine the polarity of this wire:

1. Set your multimeter to DCV or DC voltage (12 or 20V is fine).
2. Attach the (+) probe of the meter to (+)12V.
3. Probe the wire that you suspect leads to the bulb with the (-) probe of the meter.
4. Turn the ignition switch to the ON position.
5. If the meter indicates 12 volts until the light goes out you have isolated the correct wire and the wire's polarity is negative (ground while the bulb is on).
6. If the meter reads zero volts until the light goes out and then reads 12 volts, you have isolated the correct wire and the wire's polarity is positive.

finding a (+) parking light wire

The (+) parking light wire is often found near the switch. Many cars have the switch built into the turn signal lever, and in these cars the parking light wire can be found in the steering column. The same wire is often available in the kick panel or running board.

NOTE: Many Toyotas, as well as many other Asian vehicles, send a (-) signal from the switch to a relay. The relay then sends (+)12V to the bulbs. Whenever you have difficulty finding a (+) parking light wire near the switch, simply test the wires at any switch or control panel which is lit by the instrument panel lighting. Remember, you need a (+) parking light wire that does not vary with the dimmer setting.

How to find a (+) parking light flash wire with your multimeter:

1. Set to DCV or DC voltage (12V or 20V is fine).
2. Attach the (-) probe of the meter to chassis ground.
3. Probe the wire you suspect of being the parking light wire. Usually, the area near the headlight/parking light switch is an excellent area to start, as is the kick panel.
4. Turn on the parking lights. If your meter shows (+)12V, turn off the parking lights and make sure it goes back to zero.
5. If it does return to zero, turn the parking lights back on and, using the dash light dimmer control, turn the brightness of the dash lights up and down. If the meter changes more than a volt when using the dimmer, look for another wire. If it stays relatively close to (+)12V, you have found your parking light wire.

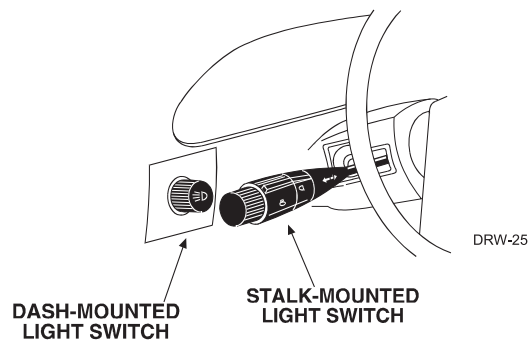

finding the door pin switch circuit

The best places to find the door switch wire are:

- At the pin switch: When testing at the pin switch, check the wire to ensure that it “sees” all the doors. Often, the passenger switch will cover all the doors even if the driver’s switch will not.
- At the dome light: This may not be your best choice if the vehicle has delayed domelight supervision, but it will work in many Hondas, or any vehicle with completely diode-isolated pin switches.

Once you have determined the wire color, the easiest place to connect to the wire is often at the kick panel, at the windshield pillar, or in the running board. When an easy location is not available, running a wire to the dome-light itself is often the best solution.

How to find a door pin switch trigger wire with your multimeter:

1. Set to DCV or DC voltage (12V or 20V is fine).
2. In most Fords, fasten the (-) probe of the meter to chassis ground. In most other cars, fasten the (+) probe of your meter to (+)12V constant.
3. Probe the wire you suspect of being the door trigger wire. If the meter reads (+)12V when any door is opened, you have found a trigger wire.

***NOTE:** Make sure the wire you use “sees” all the doors! Some newer GM vehicles lack standard-type pin switches. The dome light in these vehicles is turned on when the door handle is lifted. These usually have a blue/white or white wire coming out of the door into the kick panel which will provide a (-) trigger for all doors. Some GM vehicles (some Cavaliers, Grand Ams, etc.) have a yellow wire coming out of the door which provides a (+) door trigger.*

making your wiring connections

Before making your connections, plan how your wires will be routed through the vehicle. For instance, the red 12V constant input and the orange ground-when-armed output (for the optional starter kill relay) will often be routed together to the ignition switch harness. In order to keep the wiring neat and make it harder to find, you may wish to wrap these wires together in electrical tape or conceal them in tubing similar to what the manufacturer used.

There are two acceptable ways of making a wire connection - solder connections and crimp connectors. When properly performed, either type of connection is reliable and trouble-free. Regardless of whether you solder your connections or you use mechanical-type crimp-on connections, ensure that all connections are mechanically sound and that they are insulated.

Cheap electrical tape, especially when poorly applied, is not a reliable insulator. It often falls off in hot weather. Use good-quality electrical tape or heat shrink.

- Never twist-and-tape the wires together without soldering.
- Never use “fuse taps”, as they can damage fuse box terminals.

If you use tapping connectors such as 3M T-Taps (not to be confused with Scotch-Locks), avoid using them in higher-current applications (constant 12V, ground, etc.). Some tapping connectors are inferior in quality and should be avoided.

primary harness (H1), 12-pin connector

| | | |
|-------|-------------|---|
| H1/1 | ORANGE | (-) 500 mA ARMED OUTPUT |
| H1/2 | WHITE | (+)/(-) SELECTABLE LIGHT FLASH OUTPUT |
| H1/3 | WHITE/BLUE | (-) REMOTE START ACTIVATION INPUT |
| H1/4 | BLACK/WHITE | (-) 200 mA DOMELIGHT SUPERVISION OUTPUT |
| H1/5 | GREEN | (-) DOOR TRIGGER INPUT, ZONE 3 |
| H1/6 | BLUE | (-) MULTIPLEXED INPUT, ZONE 4 |
| H1/7 | VIOLET | (+) DOOR TRIGGER INPUT, ZONE 3 |
| H1/8 | BLACK | (-) CHASSIS GROUND INPUT |
| H1/9 | EMPTY | NOT USED |
| H1/10 | BROWN | (+) SIREN OUTPUT |
| H1/11 | RED | (+) CONSTANT POWER INPUT |
| H1/12 | RED/WHITE | (-) 200 mA CHANNEL 2 VALIDITY OUTPUT |

secondary harness (H2), 6-pin connector

| | | |
|------|-------------------|---|
| H2/1 | LIGHT GREEN/BLACK | (-) FACTORY DISARM/SPECIAL ACCESSORY OUTPUT |
| H2/2 | GREEN/WHITE | (-) FACTORY REARM |
| H2/3 | VIOLET/BLACK | (-) PROGRAMMABLE CHANNEL 4 OUTPUT |
| H2/4 | WHITE/BLACK | (-) CHANNEL 5 OUTPUT |
| H2/5 | GREY/BLACK | (-) WAIT TO START INPUT |
| H2/6 | LIGHT BLUE | (-) SECOND UNLOCK OUTPUT |

door lock harness, 3-pin connector

| | | |
|---|-------|----------------------------|
| 1 | GREEN | (-) LOCK (+) UNLOCK OUTPUT |
| 2 | EMPTY | NOT USED |
| 3 | BLUE | (+) LOCK (-) UNLOCK OUTPUT |

remote start primary harness, 7-pin connector

| | | |
|---|--------------|---|
| 1 | PINK/WHITE | 200 mA (-) PROGRAMMABLE IGN2/ACC2 RELAY TURN ON |
| 2 | YELLOW | (+) IGNITION INPUT TO ALARM |
| 3 | PINK | (-) 200 mA IGNITION RELAY TURN-ON |
| 4 | ORANGE | (-) 200 mA ACCESSORY RELAY TURN-ON |
| 5 | PURPLE | (-) 200 mA STARTER RELAY TURN-ON |
| 6 | ORANGE/BLACK | (-) ANTIGRIND/GROUND WHEN ARMED OUTPUT |
| 7 | BLUE | (-) 200 mA STATUS OUTPUT |

heavy gauge inline connector key switch interface

| | | |
|---|------------|--|
| 1 | PURPLE | (+) OUTPUT TO STARTER CIRCUIT (STARTER SIDE) |
| 2 | GREEN | ONBOARD STARTER KILL (KEY SIDE) |
| 3 | RED | (+) HIGH CURRENT 12V INPUT |
| 4 | ORANGE | (+) OUTPUT TO ACCESSORY CIRCUIT |
| 5 | PINK | (+) OUTPUT TO PRIMARY IGNITION CIRCUIT |
| 6 | RED | (+) HIGH CURRENT 12V INPUT |
| 7 | PINK/WHITE | (+) OUTPUT TO SECOND IGNITION CIRCUIT |
| 8 | RED/WHITE | (+) HIGH CURRENT 12V INPUT |

remote start secondary harness (H3), 5-pin connector

| | | |
|------|--------------|---|
| H3/1 | BLUE/WHITE | (-) 200 mA 2ND STATUS/REAR DEFOGGER- LATCHED/PULSED |
| H3/2 | GRAY | (-) HOOD PINSWITCH INPUT, ZONE 1 |
| H3/3 | BROWN | (+) BRAKE SHUTDOWN WIRE |
| H3/4 | VIOLET/WHITE | TACHOMETER INPUT WIRE |
| H3/5 | BLACK/WHITE | (-) NEUTRAL SAFETY SWITCH INPUT |

primary harness (H1) wire connection guide

H1/1 ORANGE (-) ground-when-armed output

This wire supplies a (-)500 mA ground as long as the system is armed. This output ceases as soon as the system is disarmed. The orange wire may be wired to an optional Directed Electronics 8618 starter kill relay.

H1/2 WHITE (+/-) selectable light flash output

As shipped, this wire should be connected to the (+) parking light wire. If the light flash polarity jumper under the sliding door is moved to the opposite position (see *Internal Programming Jumper* section of this guide), this wire supplies a (-) 200 mA output. This is suitable for driving (-) light control wires in Toyota, Lexus, BMW, some Mitsubishi, some Mazda, and other model cars.

(+) Positive Light Flash Output

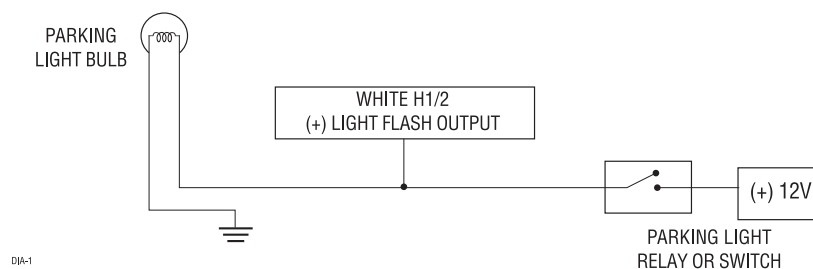

(-) Light Flash Output

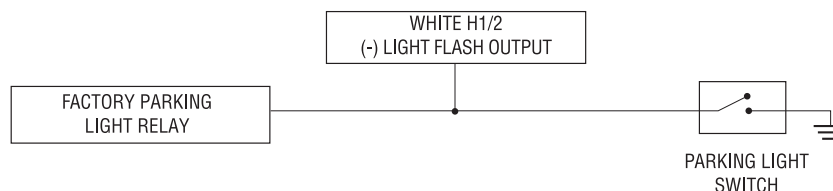

NOTE: For parking light circuits that draw 10 amps or more, the internal jumper must be switched to a (-) light flash output. (See the *Internal Programming Jumper* section of this guide.) **P/N 8617** or a standard automotive SPDT relay must be used on the H1/2 light flash output harness wire.

H1/3 WHITE/BLUE remote start (-) activation input

This input comes from the factory set to 2 activation pulses. This means that it is necessary to have 2 consecutive ground pulses on the white/blue wire for the remote start to activate or to deactivate. The same holds true for the remote control activation when set to a two pulse setting it is necessary to press the  button twice for the remote start to activate or deactivate.

NOTE: When the activation pulse count has been programmed to 1 or 3 pulses it will affect both activation inputs; the White/Blue wire and the remote control activation.

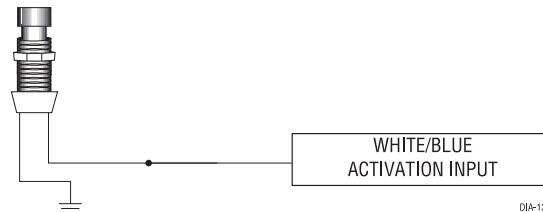

H1/4 BLACK/WHITE (-) 200 mA domelight supervision output

Connect this wire to the optional domelight supervision relay as shown below:

IMPORTANT! This output is only intended to drive a relay. It cannot be connected directly to the domelight circuit, as the output cannot support the current draw of one or more light bulbs.

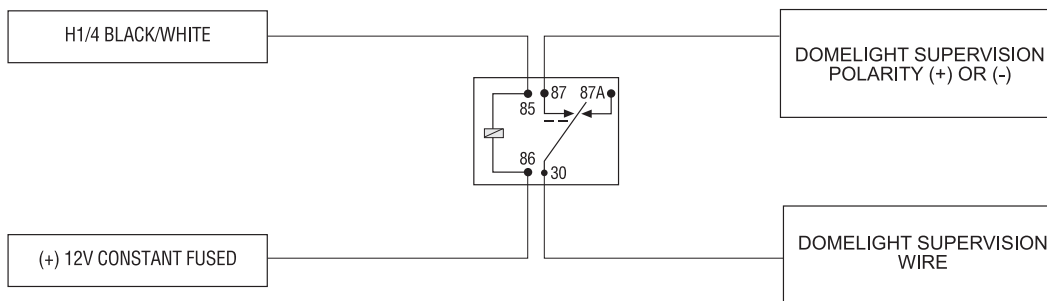

H1/5 GREEN (-) door trigger input, zone 3

Most vehicles use negative door trigger circuits. Connect the green wire to a wire which shows ground when any door is opened. In vehicles with factory delays on the domelight circuit, there is usually a wire that is unaffected by the delay circuitry. This wire will report Zone 3.

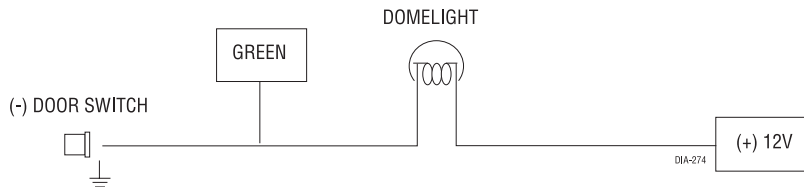

H1/6 BLUE (-) multiplex input, zone 4

Inputs shorter than 0.8 seconds will trigger the Warn Away response, while inputs longer than 0.8 seconds will trigger the full alarm sequence. If installing an optional Directed Electronics dual stage sensor, connect both the blue and the green wires of the optional sensor to this input. This wire will report Zone 4.

H1/7 VIOLET (+) door trigger input, zone 3

This wire is used in vehicles that have a positive (+) switched dome light circuit. Connect the violet wire to a wire that shows (+)12V when any door is opened, and ground when the door is closed. This wire will report Zone 3.

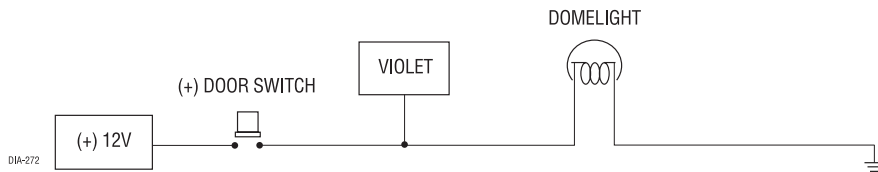

H1/8 BLACK (-) chassis ground connection

Remove any paint and connect this wire to bare metal, preferably with a factory bolt rather than your own screw. (Screws tend to either strip or loosen with time.) We recommend grounding all your components, including the siren, to the same point in the vehicle.

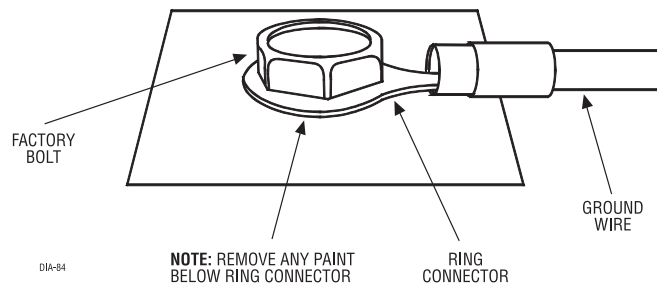

H1/10 BROWN (+) siren output

Connect this to the red wire of the siren. Connect the black wire of the siren to (-) chassis ground, preferably at the same point you connected the control module's black ground wire.

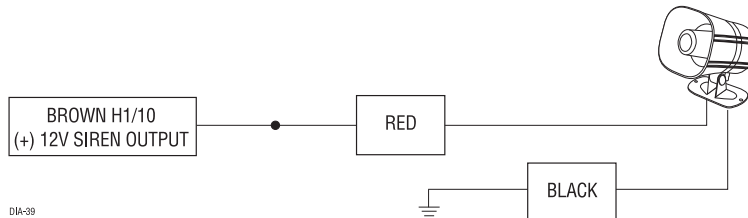

H1/11 RED (+) 12V constant power input

Before connecting this wire, remove the supplied fuse. Connect to the battery positive terminal or the constant 12V supply to the ignition switch.

NOTE: Always use a fuse within 12 inches of the point you obtain (+)12V. Do not use the 15A fuse in the harness for this purpose. This fuse protects the module itself.

H1/12 RED/WHITE channel 2, 200mA (-) output

When the system receives the code controlling Channel 2, for longer than 1.5 seconds, the red/white wire will supply an output as long as the transmission continues. This is often used to operate a trunk/hatch release or other relay-driven function.

IMPORTANT! Never use this wire to drive anything but a relay or a low-current input! The transistorized output can only supply 200 mA of current. Connecting directly to a solenoid, motor, or other high-current device will cause it to fail.

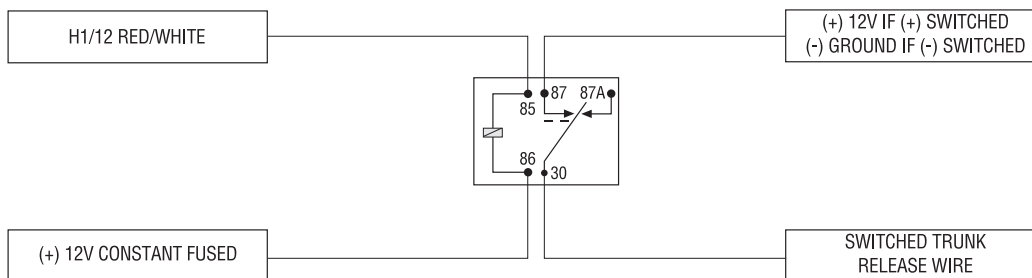

secondary harness (H2) wire connection guide

H2/1 LIGHT GREEN/BLACK (-) factory disarm output

This wire sends a negative pulse every time the remote start is activated. This can be used to pulse the disarm wire of the vehicle's factory anti-theft device. Use a relay to send a (-) or (+) pulse to the disarm wire as shown in the diagrams below. This wire can also be used as a special accessory output. (See *Feature Descriptions* section of this guide.)

Relay for Negative (-) Disarm Wire

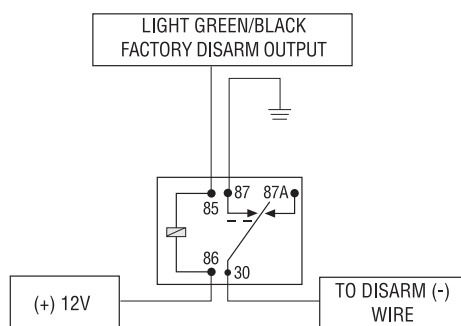

Relay for Positive (+) Disarm Wire

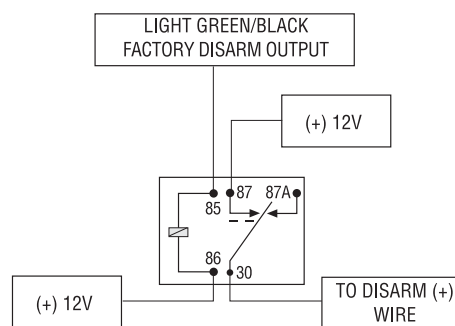

H2/2 GREEN/WHITE factory alarm rearm

This wire provides a (-) 200mA output when the remote start shuts down.

H2/3 VIOLET/BLACK 200 mA (-) programmable channel 4 output

This wire provides a (-) 200mA output whenever the transmitter button(s) controlling Channel 4 is pressed. This output can be programmed to provide the following types of outputs (see also the *Feature Menus* section):

- **Validity:** Output that will send a signal as long as the transmission is received.
- **Latched:** Output that will send a signal when the Channel 4 button(s) is pressed and will continue until the same button(s) is pressed again.
- **Latched, reset with ignition:** Similar to the latched output, this type of output turns on the first time the Channel 4 button(s) is pressed and turns off the next time the same button is pressed. This type of output additionally stops and resets whenever the ignition is turned on and then off.
- **30-second timed:** Output that will send a continuous signal for 30 seconds.
- **Second unlock output:** This output can also be programmed to provide a second unlock pulse whenever the disarm button is pressed within 15 seconds after disarming the system. This setting could be used to unlock

the passenger doors when installing progressive door locks, for instance.

NOTE: Programming Channel 4 for second unlock will link the VIOLET/BLACK H2/3 wire to the unlock button. Pressing the unlock button once will send an output to the H4/A or H4/C unlock output. Pressing the unlock button a second time within 15 seconds will send a negative (-) unlock pulse to the VIOLET/BLACK wire.

IMPORTANT! Never use this wire to drive anything but a relay or a low-current input! This transistorized output can only supply 200 mA, and connecting directly to a solenoid, motor, or other high-current device will cause the module to fail.

H2/4 WHITE/BLACK channel 5 output

This wire provides a (-) 200mA output whenever the transmitter button(s) controlling Channel 4 is pressed. This output can be programmed to provide the following types of outputs (see also the *Feature Menus* section):

- **Validity:** Output that will send a signal as long as the transmission is received.
- **Latched:** Output that will send a signal when the Channel 4 button(s) is pressed and will continue until the same button(s) is pressed again.
- **Latched, reset with ignition:** Similar to the latched output, this type of output turns on the first time the Channel 4 button(s) is pressed and turns off the next time the same button is pressed. This type of output additionally stops and resets whenever the ignition is turned on and then off.
- **30-second timed:** Output that will send a continuous signal for 30 seconds.
- **Second unlock output:** This output can also be programmed to provide a second unlock pulse whenever the disarm button is pressed within 15 seconds after disarming the system. This setting could be used to unlock the passenger doors when installing progressive door locks, for instance.

IMPORTANT! Never use this wire to drive anything but a relay or a low-current input! This transistorized output can only supply 200 mA, and connecting directly to a solenoid, motor, or other high-current device will cause the module to fail.

H2/5 GRAY/BLACK (-) diesel wait-to-start bulb input

Connect this wire to the wire in the vehicle that sends the signal to turn on the WAIT-TO-START bulb in the dashboard. In most diesels the wire is negative (ground turns on the bulb) and the GRAY/BLACK wire can be directly connected to the wire in the vehicle. If the vehicle uses a positive wire (12V to turn on the bulb) a relay must be used to change the polarity. (See *Finding the Wires You Need* section of this guide.) Here are some common colors of this wire:

- Chevrolet and GMC trucks - Light blue or dark blue
- Ford Trucks - Black/pink
- Dodge Ram Trucks - Orange/black or black/orange

NOTE! A 1-amp diode must be installed in line on the factory wire between the wait-to-start indicator and the ECM. (See the following diagram for details.)

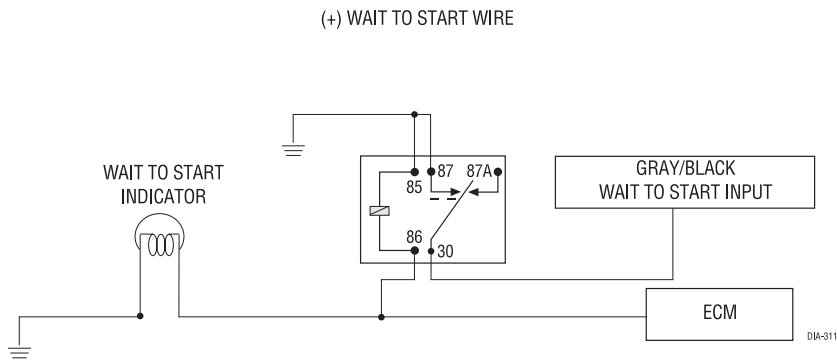
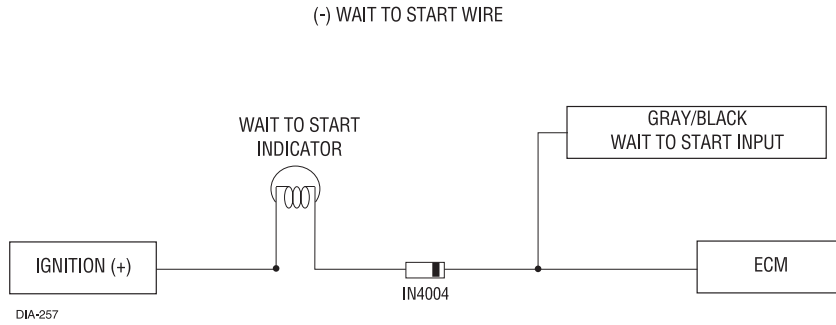

relay key switch interface wire connection guide

The five heavy gauge wires coming from the large connector are used to energize high current circuits in the vehicle. It is crucial that these connections are well-made and capable of handling the current demands. For this reason, Scotch-Locks, T-taps and other such connectors are strongly discouraged.

PURPLE (+) starter output

Connect this wire to the starter wire in the vehicle. (See *Finding the Wires You Need* section.)

GREEN starter input

For anti grind or starter kill attach this wire to the key side of the starter wire for anti grind and for the starter kill to be active.

RED (2) (+)12V input for high current outputs

Remove the two 30-amp fuses prior to connecting these wires and do not replace them until the satellite has been plugged into the control module. These wires are the source of current for all the circuits the relay satellite will energize. They must be connected to a high current source. Since the factory supplies (+)12V to the key switch that is used to operate the motor, it is recommended that these wires be connected there.

***NOTE:** If the factory supplies two separate (+) 12V feeds to the ignition switch, connect one RED wire of the satellite to each feed at the switch.*

ORANGE (+) accessory output

Connect this wire to the accessory wire in the vehicle which powers the climate control system.

PINK (+) ignition output

Connect this wire to the ignition wire in the vehicle.

PINK/WHITE (+) second ignition output

Connect this wire to the second ignition wire in the vehicle. (See *Finding the Wires You Need* section.)

NOTE: For vehicles that do not have a second ignition wire, this connection is not required.

RED/WHITE (+) 12V input

Connection for high current outputs.

remote start secondary harness (H3) wire connection guide

H3/1 BLUE/WHITE (-) status output

This wire supplies a 200mA output as soon as the module begins the remote start process. It can be used with a relay to disconnect a sensor from the system as shown below. The H3/1 BLUE wire can also be used to rearm a factory anti-theft system when the remote start shuts down. (See the *Feature Descriptions* section of this guide.) To bypass an optional sensor:

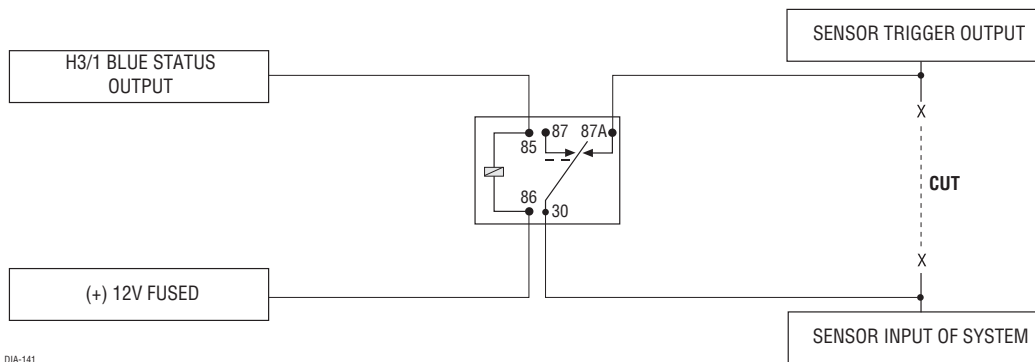

H3/2 GRAY (-) hood pinswitch input, zone 1

This wire **MUST** be connected to hood pinswitch. This input will disable or shut down the remote start when the hood is opened. It will also trigger the security system if the hood is opened while the system is armed and report Zone 1.

H3/3 BROWN (+) brake switch input, zone 1

This wire MUST be connected to the vehicle's brake light wire. This is the wire that shows (+) 12V when the brake pedal is depressed. The remote start will be disabled or shut down any time the brake pedal is depressed. This wire will also trigger the security system if the brake pedal is pressed while the system is armed and will report Zone 1.

H3/4 VIOLET/WHITE tachometer input

This input provides the module with information about the engine's revolutions per minute (RPMs). It can be connected to the negative side of the coil in vehicles with conventional coils. In multi-coil and high energy ignition systems locating a proper signal may be more difficult. (See *Finding the Wires You Need* section of this guide.) Once connected, you must teach the system the tach signal. (See the *Internal Programming Jumpers* section of this guide.)

H3/5 BLACK/WHITE neutral safety switch input

Connect this wire to the provided toggle (override) switch as shown in figure A. Connect the other wire from the toggle switch to the PARK/NEUTRAL switch in the vehicle. This wire will test with ground with the gear selector either in PARK or NEUTRAL. This will prevent the vehicle from accidentally being started while in a drive gear. This input MUST rest at ground in order for the remote start system to operate. Connected properly the vehicle will only start while in PARK or NEUTRAL.

In some vehicles, the PARK/NEUTRAL position switch activates a factory starter lock out that will not allow the starter to operate in a drive gear. In these vehicles, connect this wire to the toggle switch as shown in figure B. Connect the other wire from the toggle switch to chassis ground.

IMPORTANT! Always perform the Safety Check section of this installation guide to verify that the vehicle cannot be started in ANY drive gear and that the override switch is functioning properly.

Figure A

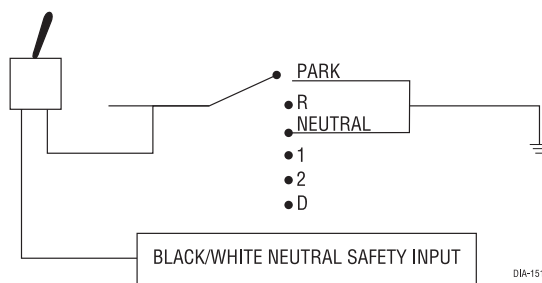
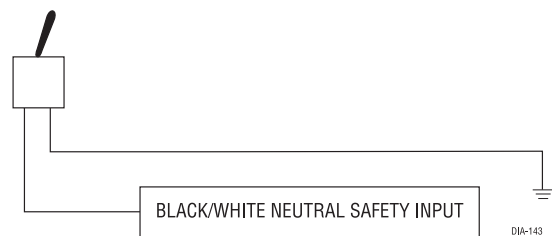

Figure B



neutral safety switch interface

Some vehicles do not have an electrical neutral safety switch. Instead, a mechanical neutral safety switch that physically interrupts the starter wire is used when the vehicle is in any drive gear. If the remote start is interfaced before this switch, it will provide protection from starting in gear. However, some vehicles combine the column shift mechanism and the mechanical neutral safety switch into one mechanical part. In these vehicles, it is impossible to interface the remote start system before the neutral safety switch. With this type of vehicle, if the car is left in a drive gear and the remote start system is activated, the vehicle will move and may cause damage to persons or property.

According to available information, the only vehicles currently manufactured this way are most General Motors trucks, sport utility vehicles and column shifting passenger cars. Available information also indicates that pre-1996 Dodge Dakota pickups with 2.5 liter motors are manufactured this way as well.

GM vehicles that have the neutral safety switch built into the column shifter can usually be identified by a purple starter wire. Typically, vehicles that use an outboard mechanical switch use a yellow wire from the ignition switch to the mechanical switch and a purple wire from the mechanical switch to the starter itself. Remember, this is only a rule of thumb and is not intended as a substitute for proper testing.

We suggest the following procedure to test for vehicles manufactured in this way.

NOTE: *You must complete the remote start system installation before doing the following test. Ensure that the remote start system is functioning normally. This includes connecting to the brake as a shut-down.*

testing the neutral safety switch

1. Make sure there is adequate clearance to the front and rear of the vehicle because it may move slightly.
2. Make sure the hood is closed and there are no remote start shut-downs active.
3. Set the emergency brake.
4. Turn the key to the "run" position, this will release the shifter.
5. Place the car in drive (D).
6. Place your foot directly over the brake pedal, but do not depress it. Be ready to step on the brake if the starter engages.
7. Activate the remote start system.
8. If the starter engages, immediately depress the brake to shut the remote start system down. If the starter does not engage, no additional safety system is required.

If the starter engages and the vehicle is a General Motors product or Dodge Dakota pickup, refer to the following text and diagrams for an alternative shut-down method which will prevent the starter from engaging. If the vehicle is not a General Motors product or a Dodge Dakota pickup, please call Directed Electronics Technical Support for an alternative shut-down method. Do not return the vehicle to the customer until this feature is properly installed!

Every vehicle built in this fashion requires that the shifter be placed in park to remove the keys from the ignition. As a result, it is possible to use the key-in-ignition sense switch to prevent remote starting if the keys are in the ignition. The following diagrams illustrate how to accomplish this. The first diagram applies to all General Motors vehicles at the present time. The second diagram applies to all pre-1996 Dodge Dakota pickup trucks with 2.5 liter motors. This solution has one side effect - if the customer inserts the key in the ignition with the driver's door open, the remote start system will shut down. If this interface is used it is important to inform the customer to close the driver's door before inserting the key into the ignition when the remote start is active. This will allow the customer to turn the key on and shut the remote start down by pressing the brake without the key sense wire shutting down the unit prematurely.

In addition, you must connect a tan (+) shut-down input to the yellow wire on the relay satellite ribbon cable. This prevents the remote start system from activating if the key is left in the "run" position. If your remote start system only has one tan input, you must use diodes to isolate the ignition circuit from the brake switch input.

However, due to future manufacturer changes in vehicles, it is possible that this may not apply to all vehicles. In addition, color variations are possible from model to model; make sure to test the circuit carefully. Please call Directed Electronics Technical Support if you need assistance in making this interface.

IMPORTANT! *Once the interface is complete, attempt to remote start the vehicle with the door closed and the key in the ignition. The vehicle should not start. If it does, recheck the connections.*

General Motors trucks, sport utility vehicles and column shifting passenger vehicles:

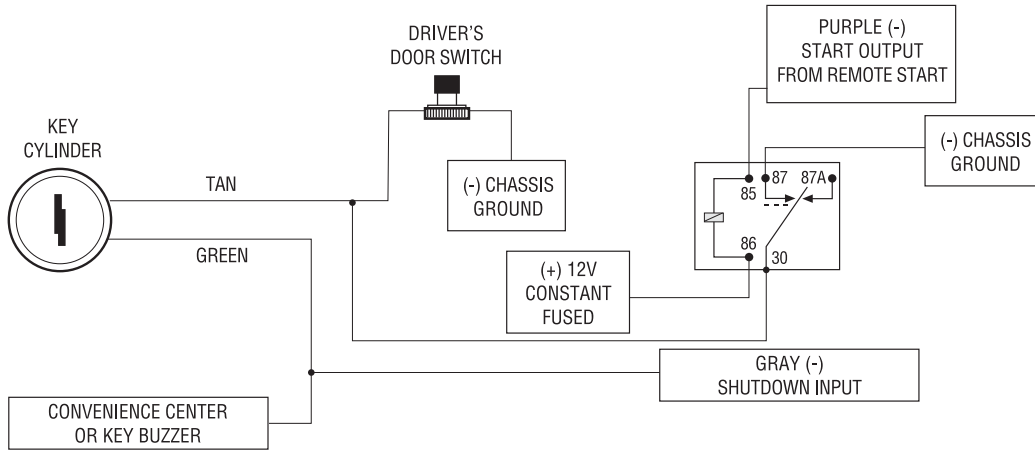

DJA-7

Pre-1996 Dodge Dakota pickups with 2.5 liter motors:

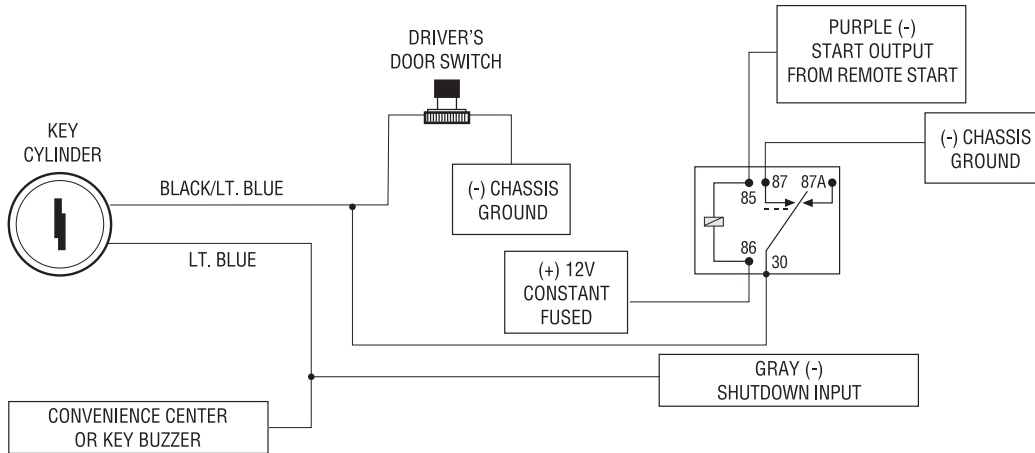

bypassing GM vehicle anti-theft systems (VATS)

Vehicles with the GM VATS (Pass Key) systems have a resistor embedded in the ignition key. If the VATS decoder module does not measure the proper resistance when the vehicle is started, the starter and fuel pump may be disabled for up to ten minutes. An optional "VATS pack" of resistors is available (p/n 652T). One of the resistors in the pack will match the resistor in the key.

The VATS wires will be two very light-gauge wires coming out of the steering column. The colors of the wires vary, but they are often contained in orange tubing - either both will be white wires, or one wire will be purple/white and the other white/black. Determine the value of the resistor in the key. Then follow the diagram below to bypass VATS during remote start operation. If the H3/1 BLUE status output has been programmed for factory security re-arm, use the H3/2 BLUE/BLACK third ignition output to control the relay.

NOTE: When connecting to the VATS wires, it is not important which wire is cut.

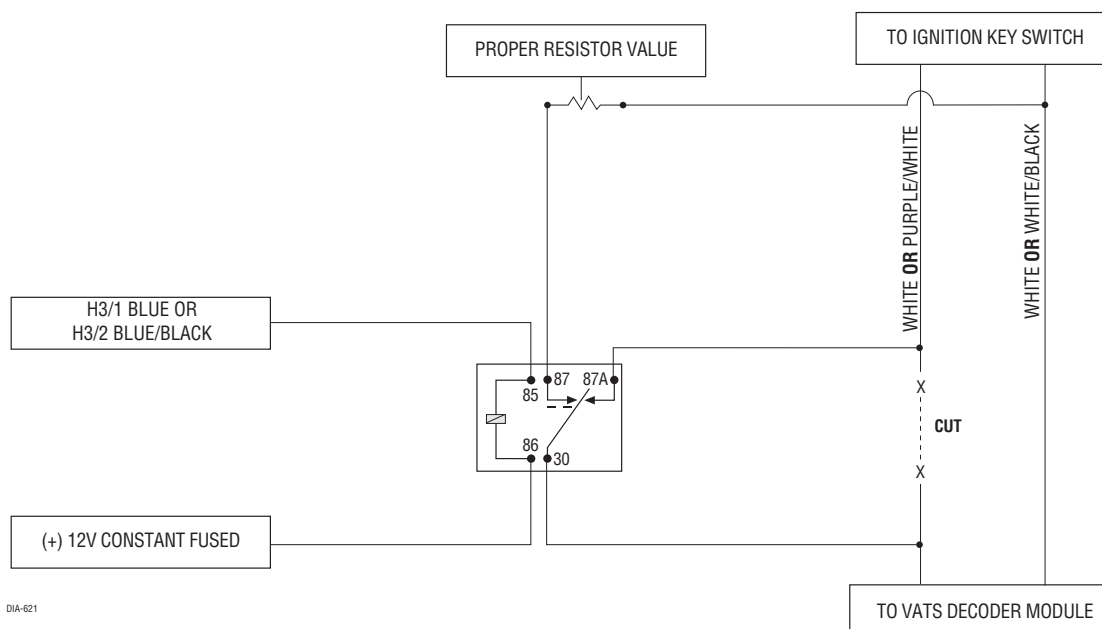

1995 and newer vehicle anti-theft systems (immobilizers)

1995 and newer vehicle anti-theft systems (immobilizers) require a bypass module. The bypass module allows for easy interfacing, while still maintaining the OEM system's integrity.

passlock I and passlock II (PL-1 and PL-2)

The Passlock I and Passlock II systems can be found in the following General Motors vehicles:

- '95 and newer Cavalier and Sunfire
- '96 and newer Achieva, Grand Am, and Skylark
- '97 and newer Intrigue, Malibu, and Cutlass
- '98 and newer trucks, vans, SUVs
- '99 and newer Alero
- 2000 and newer Impala and Saturn

Passlock I and II systems are VATS-evolved. Passlock systems still rely on the R-code to start, but the pellet is no longer placed in the key. The resistor can now be found in the key switch. This allows for a greater number of possible R-codes. In addition, Passlock systems require "seeing" the correct R-code at the correct time. To bypass Passlock I and II, **p/n 555L** or **p/n 555T** is required.

passkey III (PK-3), transponder-based systems

The Passkey III system can be found in the following vehicles:

- '97 and newer Park Avenue
- '98 and newer Cadillac
- '99 and newer U vans, Transport, Montana, and Silhouette
- 2000 and newer Grand Prix, Lesabre, Monte Carlo, Lumina, Bonneville
- 2001 and newer Aurora, Aztek and Rendezvous

Other transponder-based systems include: Acura, BMW, Dodge/Chrysler/Jeep, Ford, Honda, Infinity, Mazda, Mercedes, Mitsubishi, Nissan, Toyota, Volkswagen, and Volvo.

PK-3 and the transponder-based systems use a transponder system that locks out the ignition and fuel system. This transponder system is comprised of two parts. The first part, the transceiver, circles the key switch and is activated when the key is placed in the key switch or turned to the run position. Upon activation, the trans-

ceiver will excite the transponder, which is located (but not visible) in the head of the ignition key. The key transponder will then send a unique code back to the transceiver for evaluation. If the code matches a valid code of the system, the vehicle will be allowed to start. Most of these transponder-based systems can be bypassed using **p/n 555U**. Some may require additional parts from the vehicle manufacturer. Consult you dealer for the applications. For most Ford PATS transponders, **p/n 555F** can be used, except for the following vehicles, which will require **p/n 555U**: '97 and newer Mark VII, and 2000 and newer Taurus/Sable, Contour/Mystique and Focus.

plug-in LED and valet/program switch

These plug into the module. The Status LED plugs into the small two-pin socket, while the Valet® /Program Switch should be plugged into the larger blue two-pin connector. The Status LED fits into a $\frac{9}{32}$ -inch hole.

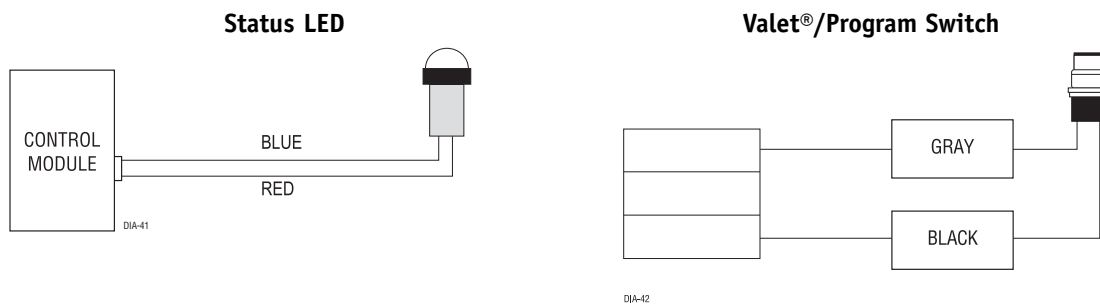

programmer interface, 3-pin black plug

The black 3-pin port is provided for personal computer programming of the unit. The unit can also be programmed using the Bitwriter (**p/n 998T**). When using the optional PC Interface module, or hand-held programmer, it is possible to configure any and all of the programmable functions as well as lock the Transmitter/Receiver and System Features Learn Routines so that unauthorized users cannot change the configuration or program transmitters to the unit.



When the learn routines have previously been programmed using an optional hand-held system programmer (**p/n 998T**) or PC Interface module, they may have been locked. Before proceeding with reprogramming the learn routines, they must be unlocked with either the 998T or the PC Interface module - this cannot be done manually with the Valet switch.

shock sensor harness, 4-pin connector

GREEN (-) multiplex input, zone 2

Inputs shorter than 0.8 seconds will trigger the Warn Away® response, while inputs longer than 0.8 seconds will trigger full alarm sequence and report Zone Two. If installing an optional Directed Electronics dual stage sensor, connect to the green wire as shown below. The diagram below eliminates the need for diodes to isolate the sensors.

Diagram for adding optional Directed Electronics dual stage sensor to green wire (Zone 2):

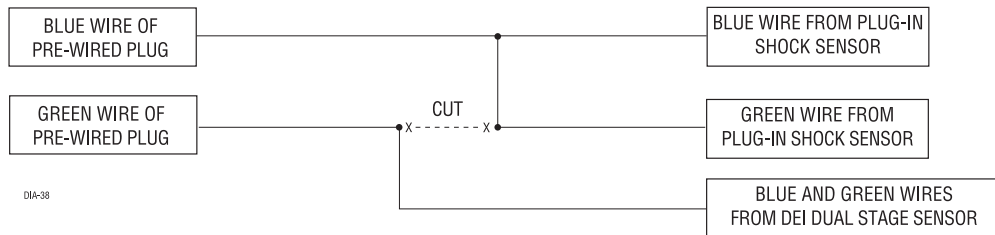

BLUE (-) multiplex input, zone 2

Inputs shorter than 0.8 seconds will trigger the Warn Away® response, while inputs longer than 0.8 seconds will trigger full alarm sequence and will also report Zone Two.

RED and BLACK: RED is (+) 12V constant, BLACK is (-) ground

Do not use these for anything besides the plug-in shock sensor.

tach learning

To learn the tach signal:



1. Start the vehicle with the key.



2. Within 5 seconds, press and **HOLD** the Valet®/Program switch.







3. The LED will light constant when the tach signal is learned.



4. Release the Valet®/Program switch.

programming jumpers

- TACH THRESHOLD OFF (DEFAULT) 
- TACH THRESHOLD ON 
- (-) LIGHT FLASH OUTPUT 
- (+) LIGHT FLASH OUTPUT (DEFAULT) 

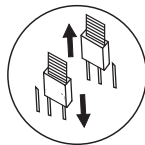

TO CHANGE
JUMPER
SETTINGS

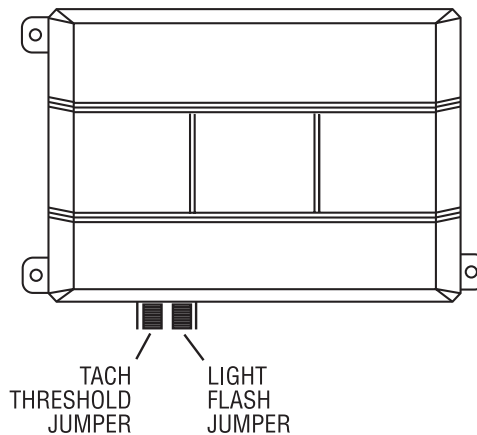

tach threshold on/off

In most cases, this jumper can be left in the OFF position. Some new vehicles use less than 12 volts in their ignition systems. The unit may have trouble learning the tach signal in these vehicles. Changing the jumper to the ON setting changes the trigger threshold of the digital tach circuit so it will work properly with these vehicles. These vehicles include many newer Dodge/Chrysler/Plymouths, such as the Neon Cirrus/Stratus/Breeze and LH-based cars.

light flash (+)/(-)

This jumper is used to determine the light flash output. In the (+) position, the on-board relay is enabled and the unit will output (+)12V on the WHITE wire, H1/2. In the (-) position, the on-board relay is disabled. The WHITE wire, H1/2, will supply a 200 mA (-) output suitable for driving factory parking light relays.

NOTE: For parking light circuits that draw 10 amps or more, the internal jumper must be switched to a (-) light flash output. P/N 8617 or a standard automotive SPDT relay must be used on the H1/2 light flash output harness wire.

transmitter/receiver learn routine™

The system comes with two transmitters that have been taught to the receiver. The receiver can store up to four different transmitter codes in memory. Use the following learn routine to add transmitters to the system or to change button assignments if desired.

Using the optional Directed Electronics Bitwriter™ or PC Interface, the learn routine may be locked. Make sure the learn routine is unlocked before programming features. If the siren generates one long chirp when attempting to program the unit, the learn routine is locked and must be unlocked using the Directed Electronics Bitwriter™ or PC before proceeding.

The Valet®/Program button, plugged into the blue port, is used for programming. There is a basic sequence to remember whenever programming this unit: Door, Key, Choose, Transmit and Release.



1. **Open a door.** (The GREEN wire, H1/5, or the VIOLET, H1/7 must be connected.)



2. **Key.** Turn the ignition on. (The heavy gauge PINK wire of the relay satellite must be connected.)



3. **Select the receiver channel.** Press and release the Valet®/Program switch the number of times necessary to access the desired channel. Once you have selected a channel, press and **HOLD** the Valet®/Program switch once more. The siren will chirp and the LED will blink the number of times corresponding to the channel that has been accessed.

NOTE: If adding a remote, a button must be taught to the unit in the Channel One or Channel Five position prior to programming other channels.

| CHANNEL NUMBER | FUNCTION | WIRE COLOR |
|----------------|--|--------------|
| 1 | Auto Learn Standard Configuration* (default) | |
| 2 | Arm only | |
| 3 | Disarm only | |
| 4 | Silent Mode™/Remote Valet®/Trunk Release | RED/WHITE |
| 5 | Remote Start | |
| 6 | Channel 4 | VIOLET/BLACK |
| 7 | Channel 5 | WHITE/BLACK |
| 8 | Short Run/Turbo | |
| 9 | Timer Mode | |
| 10 | Arm/Disarm/Panic | |
| 11 | Panic only | |
| 12 | Delete all transmitters | |

***NOTE:** For Auto Learn Configurations, see Transmitter Configurations section of this guide.

Channels Two, Three and Nine: Channels Two through Nine are used to assign the arm, disarm and panic functions to separate buttons on the remote control. Teaching a button to Channel Two erases all information about that remote from memory. Any auxiliary functions that are desired will have to be reprogrammed. Similarly, if the remote is set up to use the separate arm, disarm and panic channels and a button from that remote is entered into Channel Two, the remote will be erased from memory, and the system will only recognize the button that was entered into Channel Two.

Channel Twelve: If any transmitter button from a known transmitter is programmed to Channel Twelve, all transmitters will be erased from memory and will revert to the default feature settings. (See *Features Menu* section of this guide.) This is useful in cases when one of the customer's transmitters is lost or stolen. This will erase any lost or stolen transmitters from the system's memory. It can also be used to start from scratch if the transmitter buttons were programmed incorrectly.



4. **Press the transmitter button.** While **HOLDING** the Valet®/Program switch, press the button from the transmitter that you wish to assign to that channel. The unit will chirp indicating successful programming. It is not possible to teach a transmitter button to the system more than once.



5. **Release.** Once the code is learned, the Valet®/Program button can be released.

You can advance from one channel to another by releasing the Valet® /Program button and tapping it to advance channels and then **HOLDING** it. For example, if you want to program Channel Three after programming Channel One, release the Valet®/Program button. Press it twice and release it to advance to Channel Three. Then press it once more and **HOLD** it. The siren will chirp three times to confirm it is ready to receive the code from the transmitter.

Learn Routine™ will be exited if:

- Ignition is turned off.
- Door is closed.
- Valet®/Program button is pressed too many times.
- More than 15 seconds elapses between steps.









One long chirp indicates that Learn Routine™ has been exited.

transmitter configurations

The transmitters can be programmed with the standard or single button arm/disarm configurations by using the Auto Learn functions in the Transmitter/Receiver Learn Routine.

standard configuration

A remote that uses the standard configuration operates similarly to many factory keyless entry remotes. A standard configuration transmitter allows arming, disarming, and Panic Mode activation with separate buttons. When programmed for standard configuration, the transmitter buttons are assigned to the following functions:

- operatesArm/Lock,
Panic ON/Panic OFF
- operatesDisarm/Panic OFF
- operatesStart
- AUX**operatesChannel 2—trunk
release
-  and operate.....Timer Mode
- AUX** and operateShort Run/Turbo
timer
-  and **AUX**operate.....Channel 4
-  and **AUX**operate.....Channel 5

The standard configuration also allows the user to utilize Multi-Level Security Arming (described in the following section), a feature that cannot be accessed from a single button arm/disarm configuration transmitter.

remote control diagram

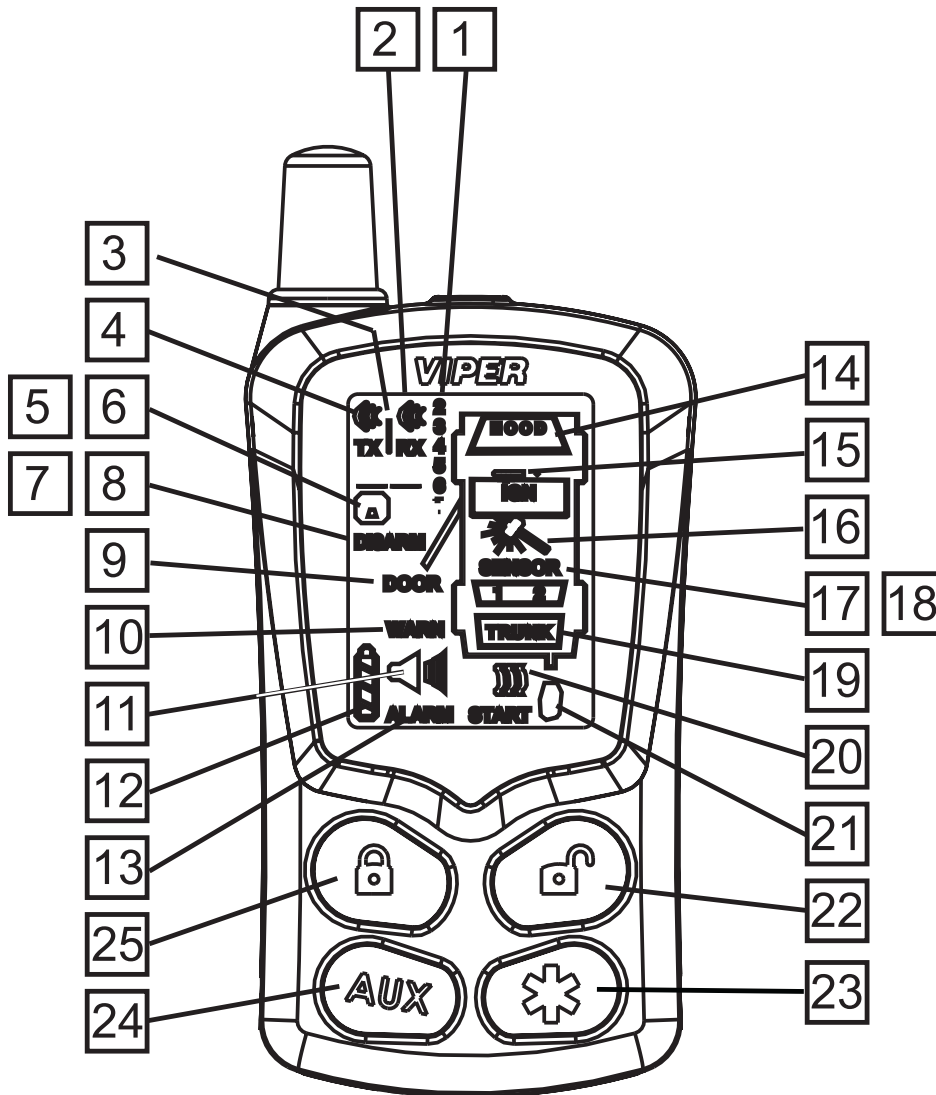





standard mode configuration

1. Auxiliary Channel Out
2. Receive Indicator
3. Signal Indicator
4. Transmit Indicator
5. Lock Status Indicator
6. Unlock Status Indicator
7. Arming Status Indicator
8. Disarming Status Indicator
9. Door Switch Input Indicator
10. Warn Away® Response Indicator
11. Siren Status Indicator
12. Battery Level Indicator
13. Trigger Response Indicator
14. Hood Switch Input Indicator
15. Ignition Switch Input Indicator
16. Sensor Response Indicator
17. Sensor 1 Indicator—Full Trigger and Warn Away®
18. Sensor 2 Indicator—Full Trigger and Warn Away®
19. Trunk Switch Input Indicator
20. Vibrate Mode Indicator
21. Remote Start Indicator
22. Disarm Button
23. Remote Start Button
24. Auxiliary Button
25. Arm Button

multi-level security arming

Multi-Level Security Arming is a feature that allows the user to select which of the system's inputs or sensors will be active and which will be bypassed when the system is armed. (See *Table of Zones* section of this guide.) Multi-Level Security Arming can only be accessed from a standard configuration transmitter. Pressing the arm button of the standard configuration transmitter again within five seconds of arming the system will activate the Multi-Level Security feature. Each time the arm button is pressed again, a different security level is selected. The different levels of security are selected as follows:

- Pressing  one time: The siren chirps once. The system is armed.
- Pressing  a second time within five seconds: The siren chirps twice followed by a long chirp. Zone Two is now bypassed.
- Pressing  a third time within five seconds: The siren chirps three times followed by a long chirp. Zone Four is now bypassed.
- Pressing  a fourth time within five seconds: The siren chirps four times followed by a long chirp. Zones Two and Four are now bypassed.
- Pressing  a fifth time within five seconds: The siren chirps five times followed by a long chirp. All input zones, except the ignition, are now bypassed.

system features learn routine

The System Features Learn Routine dictates how the unit operates. It is possible to access and change any of the feature settings using the Valet/program switch. However, this process can be greatly simplified by using the optional Personal Computer Interface or Bitwriter (p/n 998T). Any of the settings can be changed and then assigned to one of up to four transmitters. This feature is called Owner Recognition. Each time that particular transmitter is used to disarm the system, the assigned feature settings will be recalled. Owner Recognition is only possible when programming the unit via the computer interface or hand-held programmer.



If programming with the PC interface or the Bitwriter (p/n 998T), the learn routine can be locked or unlocked. If the learn routine has previously been locked, it must be unlocked before proceeding with reprogramming the learn routine. This must be done by using either p/n 998T or the PC Interface module - this cannot be done manually with the Valet switch. If the learn routine is locked, features cannot be changed.

To enter the System Features Learn Routine™:



1. **Open a door.** (The GREEN wire, H1/5, or the VIOLET, H1/7 must be connected.)



2. **Ignition.** Turn the ignition on, then back off. (The heavy gauge PINK wire of the relay satellite must be connected.)



3. **Select a Menu.** Press and **HOLD** the Valet®/Program switch. (The Valet®/Program switch must be plugged into the blue port.) After three seconds the siren will chirp once indicating entry to the Basic Features Menu. If this is the menu you wish to access, release the button and go on to Step 4. If the button is not released, you will jump to the next menu and the siren will chirp twice. There are three possible menus. Once you have selected the desired menu, release the Valet®/Program switch.

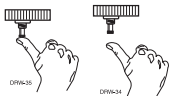

4. **Select a Feature.** Press and release the Valet®/Program switch the number of times corresponding to the feature you wish to change. For example, to access the third feature, press and release 3 times. Then press the button once more and **HOLD** it. The siren will chirp the number of times equal to the feature you have accessed.



5. **Program the Feature.** While holding the Valet®/Program switch, you can toggle the feature on and off using the remote transmitter. Pressing the button that arms the system will select the one chirp or default setting. Pressing the button that disarms the system (or the Channel Two button when in the single button arm/disarm configuration) will select the two chirp setting.

NOTE: Some features have more than two possible settings. Pressing Channel One will select the one chirp setting, pressing Channel Two will toggle through the two-chirp and higher settings.)



6. **Release.** Release the Valet®/Program switch.

Once a feature is programmed:

- Other features can be programmed within the same menu.
- Another menu can be selected.
- The learn routine can be exited if programming is complete.

To access another feature in the same menu:

1. Press and release the Valet®/Program switch the number of times necessary to advance from the feature you just programmed to the next one you want to program.
2. Then press the Valet®/Program switch once more and **HOLD** it.

For example, if you just programmed the third feature in the menu and you would like to program the seventh feature in the menu, you would press and release the Valet®/Program switch four times and then press it once more and **HOLD** it. The siren would chirp seven times to confirm access to the seventh feature.

To select another menu:

1. Press and hold the Valet®/Program switch.
2. After three seconds, the unit will advance to the next menu and the siren will chirp, indicating which menu has been accessed.

For example, if you just programmed some features in the first menu and you want to program a feature in the third menu, press and **HOLD** the Valet®/Program switch. After three seconds, the siren chirps twice indicating access to the second menu. Continue to **HOLD** the button and three seconds later the siren will chirp three times indicating access to the third menu. Features in the third menu are then programmable following steps 4 through 6 of the System Features Learn Routine procedure.

To exit the learn routine:

The learn routine will be exited if any of the following occurs:

1. Close the open door.
2. Turn the ignition on.
3. There is no activity for longer than 15 seconds.
4. The Valet®/Program switch is pressed too many times.

feature menus

The default settings are indicated in **bold** type. Features that have additional settings that can be programmed using the Bitwriter are indicated with an asterisk (*).

menu #1 - basic features

| FEATURE NUMBER | ONE-CHIRP SETTING (DEFAULT) | TWO-CHIRP SETTING |
|----------------|--|------------------------------|
| 1-1 | Active arming | Passive arming |
| 1-2 | Arm/disarm chirps on | Arm/disarm chirps off |
| 1-3 | Ignition-controlled door locks* | Standard door locks* |
| 1-4 | Ignition-controlled unlock ON | Standard unlock |
| 1-5 | Active locking only | Passive locking |
| 1-6 | Panic with ignition on | No panic with ignition on |
| 1-7 | 0.8 second door lock pulses | 3.5 second door lock pulses |
| 1-8 | Forced passive arming on | Forced passive arming off |
| 1-9 | Automatic engine disable on | Automatic engine disable off |
| 1-10 | Armed When Driving (AWD) on | AWD off |
| 1-11 | Code Hopping on | Code Hopping off |

menu #2 - advanced features

| FEATURE NUMBER | ONE-CHIRP SETTING (DEFAULT) | TWO-CHIRP SETTING |
|-----------------------|---|---|
| 2-1 | Siren output constant | Siren output pulsed |
| 2-2 | 30 second siren duration* | 60 second siren duration* |
| 2-3 | Nuisance Prevention Circuitry on | Nuisance Prevention Circuitry OFF |
| 2-4 | Progressive door trigger | Instant door trigger |
| 2-5 | Disarm from Valet, 1 pulse | Disarm from Valet, 2-5 pulses |
| 2-6 | Door sensor bypass chirp on | Door sensor bypass chirp OFF |
| 2-7 | Ignition controlled domelight on | Ignition controlled domelight OFF |
| 2-8 | Single unlock pulse | Double unlock pulse |
| 2-9 | Factory disarm with Channel Two on | Factory disarm with Channel Two OFF |
| 2-10 | Channel Four validity | Channel Four: latched/latched, reset with ignition/30-second timed/second unlock output |
| 2-11 | Channel 5 Validity | Channel Five: latched/latched, reset with ignition/30-second timed/second unlock output |

menu #3 - remote start options

| FEATURE | ONE-CHIRP SETTING (DEFAULT) | TWO-CHIRP SETTING |
|----------------|---|--|
| 3-1 | Engine checking ON | Engine checking OFF |
| 3-2 | Engine checking TACH | Engine checking VOLTAGE |
| 3-3 | Run time: 12 minutes* | Run time: 24 or 60 minutes* |
| 3-4 | Parking lights flashing | Parking lights constant |
| 3-5 | Crank time: 0.6 seconds | 0.8, 1.0, 1.2, 1.6, 1.8, 2.0, 4.0 sec. |
| 3-6 | Voltage check - high | Voltage check - low |
| 3-7 | Start Run/Turbo-1 min. | 3, 5, 10 min. |
| 3-8 | Activation pulse count-1 | Activation pulse count: 2 |
| 3-9 | 2nd Ignition/Accessory output: ignition | Accessory |
| 3-10 | Accessory state during start: ON | OFF |
| 3-11 | 2nd status output: Normal | Rear defogger: latch 5 min./pulse OFF |
| 3-12 | Anti grind: ON | Anti grind: OFF |

feature descriptions

The features of the system are described below. Features that have additional settings that can be selected only when programming with the PC interface or Bitwriter are indicated by the following icon:



menu #1 - basic features

1-1 ACTIVE/PASSIVE ARMING: When active arming is selected, the system will only arm when the transmitter is used. When set to passive, the system will arm automatically 30 seconds after the last door is closed. To alert the consumer of passive arming, the siren will chirp 20 seconds after the door is closed. This provides the consumer with an audible warning prior to the system actually arming. At the 30 second mark, the system will arm, but the siren will not chirp.

1-2 CHIRPS ON/OFF: This feature controls the chirps that confirm the arming and disarming of the system.

1-3 IGNITION CONTROLLED DOOR LOCKS ON/OFF: When turned on, the doors will lock three seconds after the ignition is turned on and unlock when the ignition is turned off. There are separate steps for ignition lock and ignition unlock. They can be programmed on or off independently.

1-4 IGNITION CONTROLLED UNLOCK: When turned ON the doors will unlock when the ignition is turned OFF.

1-5 ACTIVE/PASSIVE LOCKING: If passive arming is selected in Feature 1-1, then the system can be programmed to either lock the doors when passive arming occurs, or only lock the doors when the system is armed via the transmitter. Active locking means the system will not lock the doors when it passively arms. Passive locking means that the system will lock the doors when it passively arms.

***NOTE:** Remember, when passive arming is selected, the unit will chirp 20 seconds after the last door is closed. The system does not actually arm or lock the doors until 30 seconds after the door has been closed.*

1-6 PANIC WITH IGNITION ON: This feature controls whether or not the panic mode is available with the ignition on. In some states, there are laws prohibiting a siren sounding in a moving vehicle. This feature makes the system compliant with these regulations.

1-7 DOOR LOCK PULSE DURATION: Some European vehicles, such as Mercedes-Benz and Audi, require longer lock and unlock pulses to operate the vacuum pump. Programming the system to provide 3.5 second pulses, will accommodate the door lock interface in these vehicles. The default setting is 0.8 second door lock pulses. Some modification to the door lock harness (H2) is also necessary. (See (+/-) *Door Lock Outputs Harness (H4)* section,

"Type E - Mercedes-Benz and Audi -1985 and Newer" diagram.)

1-8 FORCED PASSIVE ARMING ON/OFF: To use this feature, passive arming must be selected in Feature 1-1. When turned on, forced passive arming will ensure that the system will passively arm, even if a zone is left open or invalid. Forced passive arming occurs one hour after the ignition is turned off.

1-9 AUTOMATIC ENGINE DISABLE (AED) ON/OFF: AED is a full-time, passive starter disable that works independently of the security system. When turned on, the orange, ground-when-armed output (H1/1) will activate 30 seconds after the ignition is turned off. The LED will flash at half its normal rate when the ignition is turned off to indicate that AED is active and will interrupt the starter in 30 seconds. AED does not occur in Valet® mode and can be bypassed using the emergency override procedure. The transmitter can be used to disarm AED, however, the system must be armed and then disarmed, using the transmitter, to disarm AED.

1-10 ARMED WHILE DRIVING (AWD) ON/OFF: In the default setting (Armed While Driving), the system can be armed with the ignition on. When armed, the ground-when-armed is not active and the sensors are bypassed. The door triggers will remain active.

1-11 CODE HOPPING™ ON/OFF: The system uses a mathematical formula to change its code each time the transmitter and receiver communicate. This makes the group of bits or "word" from the transmitter very long. The longer the word is, the easier it is to block its transmission to the unit. Disabling the Code Hopping™ feature lets the receiver ignore the Code Hopping™ part of the transmitted word. As a result, the unit may have better range with Code Hopping™ off.

menu #2 - advanced features

2-1 SIREN OUTPUT CONSTANT/PULSED: The system can be programmed to output pulses instead of a continuous output when the system is triggered. This is useful to honk the factory horn in applications where a siren is undesirable. Remember that the unit is only capable of supplying 1 amp of current. A relay will be required to interface with most factory horn systems.



2-2 SIREN DURATION 30/60 SECONDS: It is possible to program the unit to sound for 30 or 60 seconds during the triggered sequence. Some states have laws regulating how long a security system can sound. When using the TechSoft Programmer or Bitwriter™, the siren can be programmed to sound for any length of time from 1 second to 180 seconds. Use the right and left arrows or the plus (+) and minus (-) keys on your keyboard to change the siren duration in 1 second intervals. Holding down the key will rapidly increase or decrease the setting. The desired siren duration can also be directly entered by using the number keys on your computer's keyboard.

2-3 NUISANCE PREVENTION CIRCUITRY™ (NPC™) ON/OFF: NPC™ stops repeated triggering of the same zone. If one zone is triggered three times in one hour, that zone is bypassed for one hour, starting from the time of the third trigger. During that hour, if the system sees a trigger on that zone again, the system resets the one hour timer. If one hour passes and the zone has not triggered again, the zone is activated and can trigger the

system again. NPC™ only monitors sensor inputs, and does not bypass the door trigger or the ignition trigger at any time. If NPC™ is turned off, the system will respond to repeated triggers on the sensor inputs and will do so indefinitely. Some states have laws regulating how many times a security system can trigger before it is considered a nuisance and the vehicle is towed away.

2-4 PROGRESSIVE DOOR TRIGGER ON/OFF: The system responds to a door trigger input with a progressive response. When the door is opened with the system armed, the siren will chirp 10 times prior to the full triggered sequence. The door trigger is still treated as an instant trigger and closing the door quickly will not prevent full triggered sequence from occurring. If the progressive door trigger is programmed off, the full siren output will occur the moment the door is opened.

2-5 VALET PULSE COUNT 1 TO 5 PULSES: The system can be programmed to count the number of presses of the valet switch before disarming the security system. The factory default setting is one pulse. The unit can also be set for two to five pulses.

Ghost Switch option: For added security, the GRAY wire on the two-pin Valet®/Program plug can be connected to any switch in the vehicle that provides a positive (+) momentary pulse.

2-6 DOOR SENSOR BYPASS CHIRP ON/OFF: This feature controls the error chirp that is generated if the system is armed with the door trigger active. This is useful in vehicles that have a long dome light delay after the door has been closed. If the system is armed before the dome light has turned off, the security system will generate the door trigger error chirp. If this error chirp is not desired, use this feature to disable the door open error chirp. If the bypass chirp is turned off, no bypass chirp will be generated, even if a door is accidentally left open.

2-7 IGNITION CONTROLLED DOME LIGHT SUPERVISION ON/OFF: If turned on, the system will turn on the dome light for 60 seconds when the ignition is turned off. The optional dome light supervision feature must be installed as described in the Wire Connection Guide.

2-8 DOUBLE PULSE UNLOCK ON/OFF: Some vehicles require two pulses on a single wire to unlock the doors. When the double pulse unlock feature is turned on, the BLUE H4/C wire will supply two negative pulses instead of a single pulse. At the same time, the GREEN H4/A wire will supply two positive pulses instead of a single pulse. This makes it possible to directly interface with double pulse vehicles without any extra parts.

2-9 FACTORY ALARM DISARM WITH CHANNEL 2: In the default setting the factory alarm disarm output will disarm the factory alarm system any time the button(s) controlling Channel Two is pressed.

2-10 CHANNEL 4 VALIDITY/LATCHED/LATCHED RESET WITH IGNITION/30 SECOND TIMED/SECOND UNLOCK OUTPUT: Channel Four can be programmed for these output configurations. The unit is set to the default validity output. To change the configuration, use the two-chirp setting to toggle through the different configurations.

2-11 CHANNEL 5 VALIDITY/LATCHED/LATCHED RESET WITH IGNITION/30 SECOND TIMED/SECOND UNLOCK

OUTPUT: Channel Four can be programmed for these output configurations. The unit is set to the default validity output. To change the configuration, use the two-chirp setting to toggle through the different configurations.

menu #3 - remote start options

3-1 ENGINE CHECKING ON/OFF: In the default setting the remote start will monitor either the vehicle's tach wire or voltage depending on the programming of feature 3-2. If programmed OFF the vehicle will crank for the programmed crank time (feature 3-5) and will not verify with tach or voltage that the car is running. In the OFF setting, if the vehicle fails to start, the ignition can stay on for the entire run duration. Using tach or voltage check is always recommended if possible.

3-2 CHECKING TYPE TACH/VOLTAGE: Selects the method of engine monitoring. If set to TACHOMETER the unit will reference the learned tach signal to disengage the starter. In addition it will monitor the RPM and shut down if the engine RPM is too high or too low. When set to VOLTAGE, the unit will crank the starter for the programmed time and then attempt to sense that the engine is running by detecting an increase in voltage. The threshold for the voltage check is selectable in feature 3-6.



3-3 RUN TIME 12, 24, 60 MINUTES: Selects the time in minutes that the system will operate the engine until the system "times out". This is the maximum operation period and the system may be shut down using a shutdown at any time. Using the Bitwriter, the run time can be programmed for any duration from 1-60 minutes.

3-4 PARKING LIGHTS FLASHING/CONSTANT: In the default setting, the unit will flash the vehicle's parking lights (if connected) while remote started. The constant setting will turn the parking lights on solid for the entire run duration.

3-5 CRANK TIME 0.6/0.8/1.0/1.2/1.4/1.6/1.8/2.0/4.0 SECONDS: If the unit is programmed for no engine checking or voltage sense, the crank time must be set to the appropriate duration. The default setting is 0.6 second. If a different crank time is desired, select feature 3-5 and select either 0.6 second by using the one-chirp setting or toggle through the higher settings by using the two-chirp settings.

3-6 VOLTAGE CHECK HI/LOW: This feature only functions when programmed for voltage sense. Some vehicles have many accessories, which are turned on when remote started. In these vehicles, the variation of voltage between the engine off and the car running is very small and the remote start unit may "think" the vehicle has not started. This can cause the remote start to shut-down after the car has been started. If this happens program this feature to the LOW position.

3-7 SHORT RUN/TURBO: When the  and **AUX** buttons on the transmitter are pressed simultaneously, the vehicle will start for the programmed short run time. The factory default is 1 minute.

3-8 ACTIVATION PULSE COUNT: This allows the system to use 1 or 2 pulses to activate the remote start sequence.

Note! 1 or 2 pulses on the WHITE/BLUE remote start activation input wire as well as the  button of the remote control.

3-9 2nd IGNITION/2nd ACCESSORY OUTPUT: This will allow the PINK/WHITE to be used as a 2nd ignition or an accessory.

3-10 ACCESSORY STATE DURING WAIT-TO-START: This feature will allow the selection of the accessory output to be ON or OFF during wait-to-start.

3-11 2nd STATUS OUTPUT: This feature will allow selection of status output or a rear defogger mode that turns on ten seconds after the vehicle has started. The defogger mode has two selections, latched or pulsed. Latched mode will only stay on for 5 minutes.

3-12 ANTI-GRIND ON/OFF: With the anti-grind On (default) the ground-when-armed output will be active during remote start operation. If accessories such as a voice module or window module are added to the unit, it may be necessary to program this feature off.

nuisance prevention circuitry™

NPC™ requires that you change the way you test the system as NPC™ will bypass an input zone for 60 minutes. If the system “sees” the same zone trigger three times AND the triggers are spaced less than an hour apart, the system will bypass that input zone for 60 minutes. If that zone does not attempt to trigger the system during the 60-minute bypass period, the zone’s monitoring will begin again at the end of the hour. If it does attempt to trigger while bypassed, the 60-minute bypass starts over again.

Disarming and rearming the system does not reset NPC™. The only way to reset NPC™ is for the 60 minutes to pass, without a trigger, or for the ignition to be turned on. This allows the system to be repeatedly triggered, disarmed and rearmed, and still allow NPC™ to bypass a faulty zone.

When disarming the system, 5 chirps indicate NPC is activated. The LED will report the zone that has been bypassed. (See *Diagnostics* section of this guide.)

valet mode

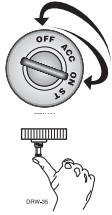

To enter or exit valet mode with the valet/program switch:



1. Turn the ignition key on and then off.
2. At anytime during the next 10 seconds, press and release the Valet® switch. Now the Status LED will light constantly if you have entered Valet® Mode, and go out if you have exited Valet® Mode.

To enter or exit valet mode with the transmitter:

To enter or exit Valet® Mode with a transmitter:

1. Open any door.
2. Press  on the transmitter.
3. Press .
4. Press  again. You have now entered or exited Valet Mode (verify by checking your status LED).

timer mode

This unit can be programmed to start and run the engine every three hours, for a maximum of six cycles. The engine will run for the programmed run time and then shut down. After three hours, the system will restart the engine.

IMPORTANT! *Timer Mode should be used only in open areas. Never start and run the vehicle in an enclosed space such as a garage or carport.*

To enter or exit timer mode with the transmitter:

The same procedure may be used to enter or exit Timer Mode using the remote transmitter:

1. Remote start the vehicle by pressing  and **AUX** simultaneously.
2. The lights will flash 4-times.
3. After 1-second the car will start and the timer mode will run for the specified time period.

The system is in Timer Mode. The engine may be allowed to run for its programmed run time, or the transmitter can be used to shut down the engine. Either way, the remote start system will restart the engine again in three hours. Timer Mode is exited automatically after the sixth run cycle.

To enter or exit timer mode manually:

1. Make sure the remote start system is not operating the engine.
2. Turn the ignition on.

Timer Mode will be exited and the parking lights will flash four times.

table of zones

When using the Diagnostic functions, use the Table of Zones to see which input has triggered the system. It is also helpful in deciding which input to use when connecting optional sensors and switches.

| ZONE NO. | TRIGGER TYPE | INPUT DESCRIPTION |
|----------|--------------------------------|-------------------------------------|
| 1 | Multiplexed Input | BLUE (H1/6) |
| 2 | Multiplexed Shock Sensor Input | Mux BLUE wire. |
| 3 | Door Trigger | GREEN (H1/5) and VIOLET (H1/7). |
| 4 | Multiplexed Shock Sensor | Mux GREEN wire |
| 5 | Ignition | Yellow ribbon harness wire |
| 6 | Hood Brake Trigger | GRAY on the 6-pin shutdown harness. |

***NOTE:** The Warn Away® response does not report on the LED.*

shutdown diagnostics



to perform shutdown diagnostics

1. With the ignition OFF, press and **HOLD** the Valet/Program button.
2. Turn the ignition ON and then back OFF while **HOLDING** the Valet/Program button.
3. Release the Valet/Program button.
4. Press and release the Valet/Program button. The LED will report the last shutdown for one minute or until the ignition is turned on.

| LED FLASHES | SHUTDOWN MODE |
|-------------|---|
| One | Timed out |
| Two | Over-rev shutdown |
| Three | Low or no RPM |
| Four | Transmitter shutdown (or optional push-button) |
| Six | (-) Shutdown (H3/3 GRAY) or (+) Shutdown (H3/4 BROWN) |
| Seven | (-) Neutral safety shutdown (H3/6 BLACK/WHITE) |
| Eight | Wait-to-start timed out |

long term event history

The system stores the last two full triggers in memory. These are not erasable. Each time the unit sees a full trigger, the older of the two triggers in memory will be replaced by the new trigger. To access long term event history:

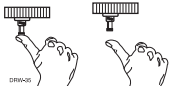
- 
 1. With the ignition off, press and **HOLD** the Valet®/Program switch.
- 
 2. Turn on the ignition.
- 
 3. Release the Valet®/Program switch.
- 
 4. Press and release the Valet®/Program switch within 5 seconds. The LED will flash in groups indicating the last two zones that triggered the unit for one minute or until the ignition is turned off.

NOTE: The Warn Away triggers are not stored to memory and will not be reported.

safety check

Before vehicle reassembly, the remote system must be checked to ensure safe and trouble-free operation. The following test procedure must be used to verify proper installation and operation of the system. The installation must be completed before testing, including connection to the brake switch and hood switch.

1. Test the BRAKE shutdown circuit: With the vehicle in Park (P), activate the remote start system. Once the engine is running, press the brake pedal. The engine should shut down immediately. If the engine continues to run, check the brake circuit connection.
2. Test the HOOD PIN shutdown circuit: With the vehicle in Park (P), open the hood. Activate the remote start system. The vehicle should not start. If the starter engages, check your hood pin and connections.

NOTE: *If programmed for Diesel Mode, the system will turn on the ignition, but the starter should not engage with the hood open.*

3. Test the NEUTRAL SAFETY shutdown circuit:

IMPORTANT! *Make sure there is adequate clearance to the front and rear of the vehicle before attempting this test.*

- a. Make sure the hood is closed and no other shutdown circuits are active.
- b. Set the emergency brake.
- c. Turn the ignition key to the run position but do not start the engine.
- d. Put the vehicle in Drive (D).
- e. Put your foot over the brake pedal but do not press down on it. Be ready to step on the brake to shut-down the remote start system.
- f. Activate the remote start system.
 - If the starter engages, immediately step on the brake to shut down the system. If it does engage, recheck the neutral safety input connection. The vehicle may use a mechanical neutral safety switch. (See H2/6 BLACK/WHITE neutral safety switch input in *Remote Start Harness Wire Connection Guide* section of this guide.)
 - If the starter does not engage, the test is complete.

Once the system passes the three tests, the vehicle can be re-assembled and delivered. Do not use the remote start system or finalize the installation if it fails any of the safety check tests.

troubleshooting

alarm troubleshooting

■ Shock sensor doesn't trigger the alarm:

Has the NPC™ system been triggered? If so, you will hear 5 chirps when disarming. To check this, turn the ignition key on and off to clear the NPC™'s memory, and then retest the shock sensor. For a detailed description of NPC™, see *Nuisance Prevention Circuitry* section of this guide.

■ Door input does not immediately trigger full alarm. Instead, chirps are heard for the first 3 seconds:

That's how the progressive two-stage door input works! This is a feature of this system. This is an instant trigger, remember, since even if the door is instantly closed again, the progression from chirps to constant siren will continue.

■ Closing the door triggers the system, but opening the door does not:

Have you correctly identified the type of door switch system? This happens often when the wrong door input has been used. (See *Door Lock Harness Wire Connection Guide* section of this guide.)

■ System will not passively arm until it is remotely armed and then disarmed:

Are the door inputs connected? Is the H1/6 blue wire connected to the door trigger wire in the vehicle? Either the H1/5 green or the H1/7 violet should be used instead. (See wiring diagrams.)

■ Door input does not respond with the progressive trigger, but with immediate full alarm:

Does the Status LED indicate that the trigger was caused by the shock sensor? (See *Diagnostics* section of this guide.) The shock sensor, if set to extreme sensitivity, may be detecting the door unlatching before the door switch sends its signal. Reducing the sensitivity can solve this problem.

■ The Valet®/Program switch doesn't work.

Is it plugged into the correct socket? See *Plug-In LED and Valet®/Program Switch* section of this guide.

■ Status LED doesn't work.

You've probably guessed already, but here goes: Is it plugged in? (See *Plug-In LED and Valet®/Program Switch* section of this guide.) Is the LED plugged into the correct socket?

■ Door locks operate backwards.

This unit has easily-reversed lock/unlock outputs. Recheck wire connections to see if you have reversed these.

remote start troubleshooting

■ The remote start will not activate.

1. Check the harnesses and their connections. Make sure that the harnesses are completely plugged into the remote start module. Make sure there are good connections to the vehicle wiring.

2. Check voltage and fuses. Use a meter to check for voltage between the red wire in the 5-pin ribbon harness and the black ground wire. If you have less than battery voltage, check the 3A and both 30A fuses on the relay satellite. Also make sure that the ground wire connects to a good chassis ground point.
3. Check diagnostics. The diagnostics will tell you which shutdown is active or not connected.

■ **The remote start will activate, but the starter never engages.**

1. Check for voltage on the purple starter wire two seconds after the remote start becomes active. If there is voltage present, skip to Step 4. If there is not voltage present, advance to Step 2.
2. Check the 30A fuses.
3. Check diagnostics. If the gray/black wire is detecting ground upon activation, the starter will not crank.
4. Make sure the purple starter wire is connected on the starter side of the optional starter kill/anti-grind relay.
5. Does the vehicle have an immobilizer? Some immobilizer systems will not allow the vehicle to crank if active.
6. Check connections. The two red heavy gauge input wires on the relay satellite should have solid connections. "T-taps" or "scotch locks" are not recommended for any high current heavy gauge wiring. Also, if the vehicle has more than one 12-volt input wire, then connect one red wire to each.

■ **The vehicle starts, but immediately dies.**

1. Does the vehicle have an immobilizer? The vehicle's immobilizer will cut the fuel and/or spark during unauthorized starting attempts.
2. Is the remote start programmed for voltage sense? If so, the start time may not be set high enough, or you may have to adjust the voltage threshold in programming. Voltage sense will not work on some vehicles.
3. Check diagnostics. Sometimes a shutdown will become active during cranking or just after cranking.

■ **The vehicle starts, but the starter keeps running.**

1. Is the system programmed for engine checking off or voltage sense? When programmed for either of these features, the engine cranks for the preprogrammed crank time regardless of how long it takes for the vehicle to actually start. Adjust to a lower cranking time.
2. Was the Tach Learn successful? The LED must light solid and bright to indicate a successful learn.
3. Make sure that there is a tach signal at the purple/white tach input wire of the remote start. If there is not a tach signal, recheck the connection to the vehicle's tach wire and make sure the wire is not broken or shorted to ground leading to the remote start.

■ **The vehicle will start, but will only run for 10 seconds.**

1. Is the remote start programmed for voltage sense? Try programming the unit for low voltage reference. If this does not work, a tach wire should be used.
2. Check diagnostics.

■ **The climate control system does not work while the unit is operating the vehicle.**

Either the wrong accessory wire is being energized or more than one ignition or accessory wire must be energized in order to operate the climate control system.

wiring quick reference guide

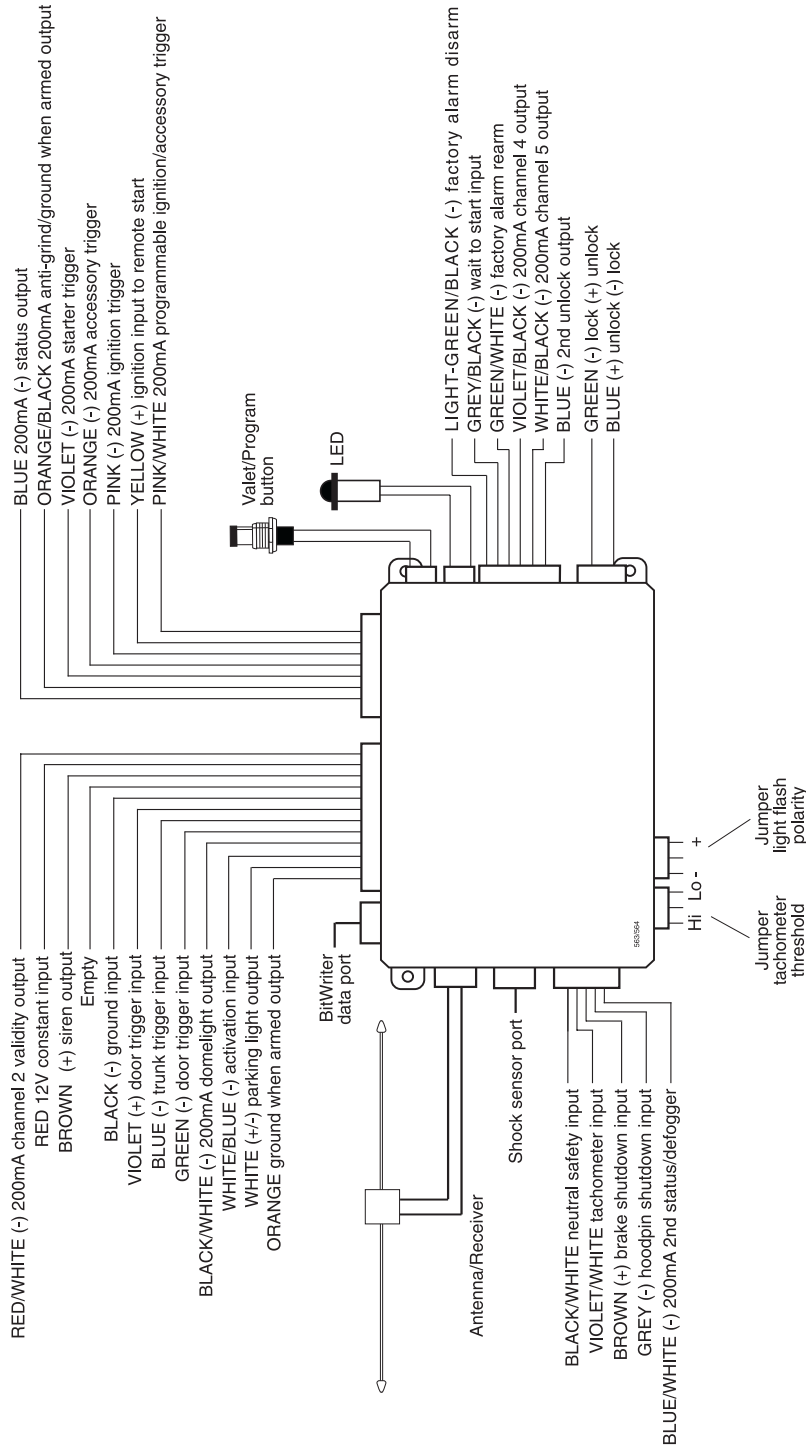

relay satellite wiring quick reference guide

